

DC265 Quick Start Guide

⚠ Important

* Please activate your warranty at www.lumens.com.tw/reg

* Please visit our website www.lumens.com.tw/goto.htm to download latest version of Software, Multilingual User Manual and Quick Start Guide.

1. Package Contents

Main Unit

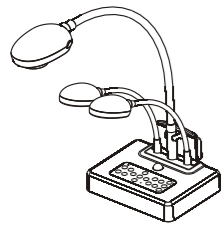

Quick Start Guide

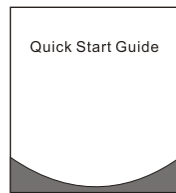

* To download this manual in other languages, visit Lumens website

VGA Cable

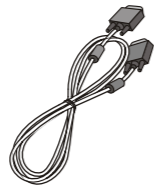

USB Cable

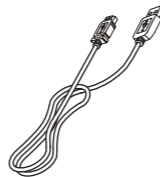

C-Video Cable

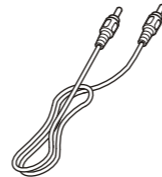

Remote control



Remote Control Holder

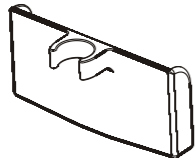

Extender Adapter



Audio Cable

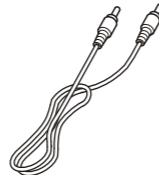

Power Cord

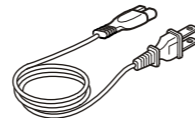

* Appearance may vary in different countries

Microscope Adapter



Accessory Pouch

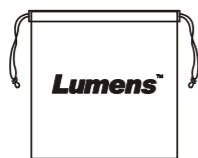

Padded Carry Bag (Optional)



2. Getting Started

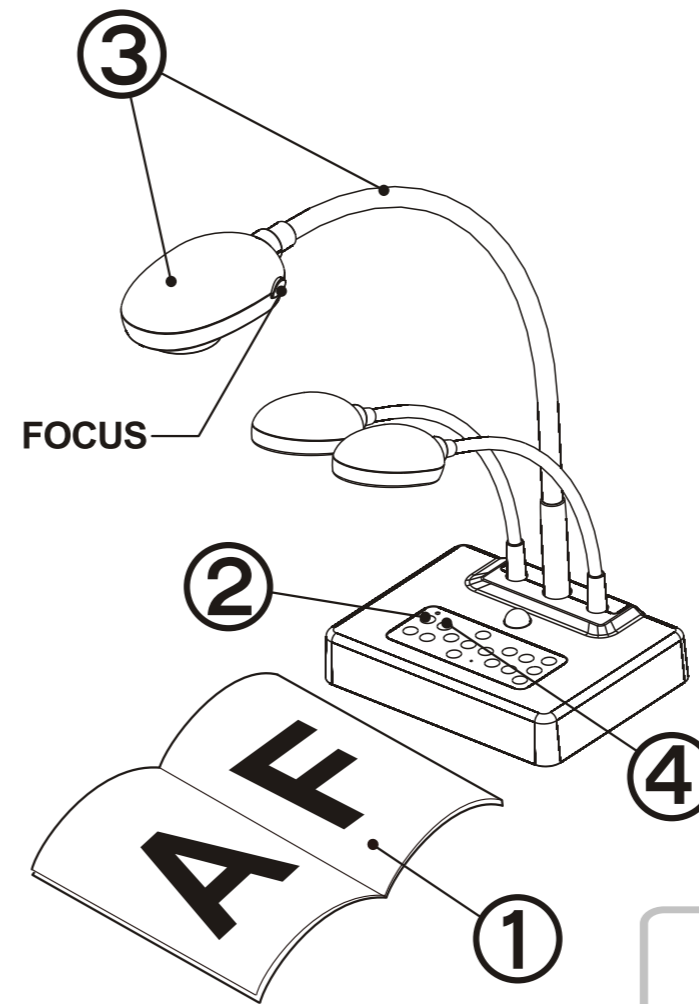

- ① Place an object to be displayed under the camera.
- ② Turn the power on.
- ③ Adjust the gooseneck and lens to appropriate position.
- ④ Press the [AUTO TUNE] button to optimize the image. You are ready to teach / present.

* Each time the camera head is moved, press the [FOCUS] button to refocus the lens.

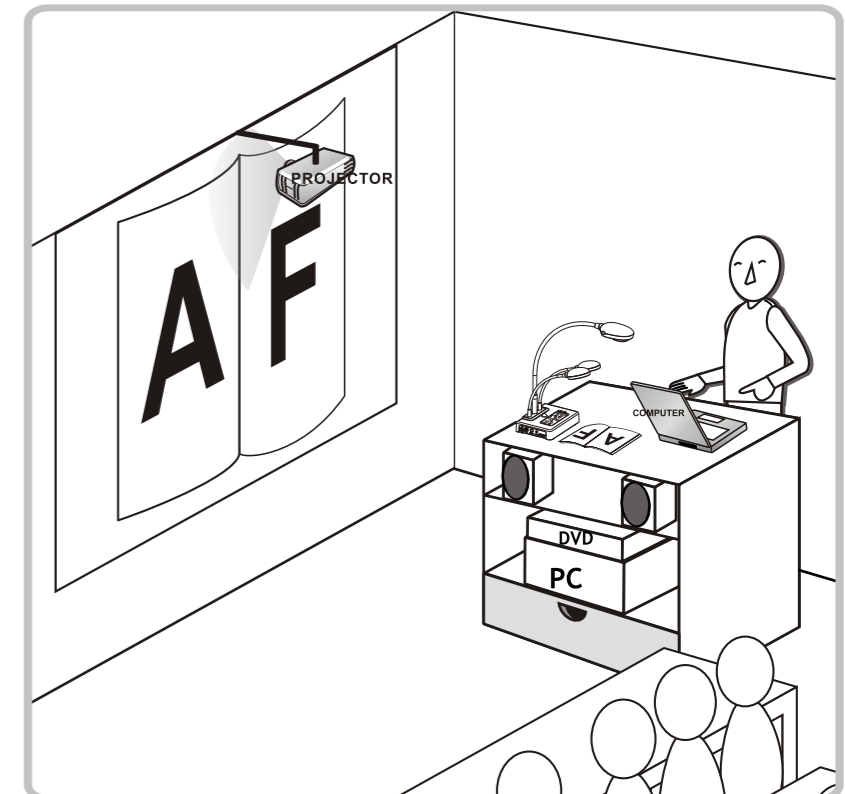

3. Installation & Connection

▼ Connect to a Projector or Monitor

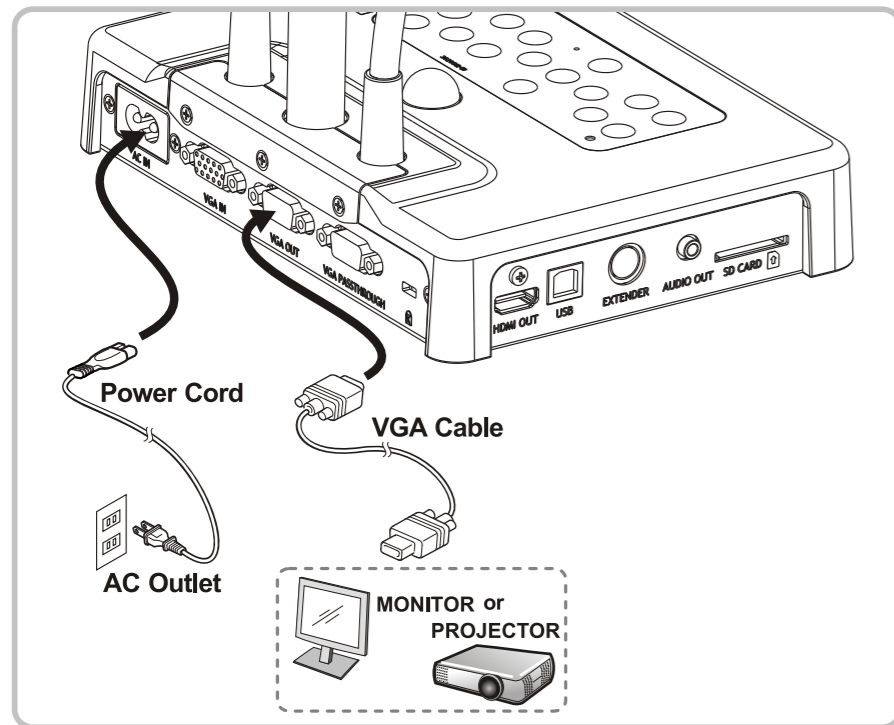

▼ Connect to a Computer and Use Lumens' Software.

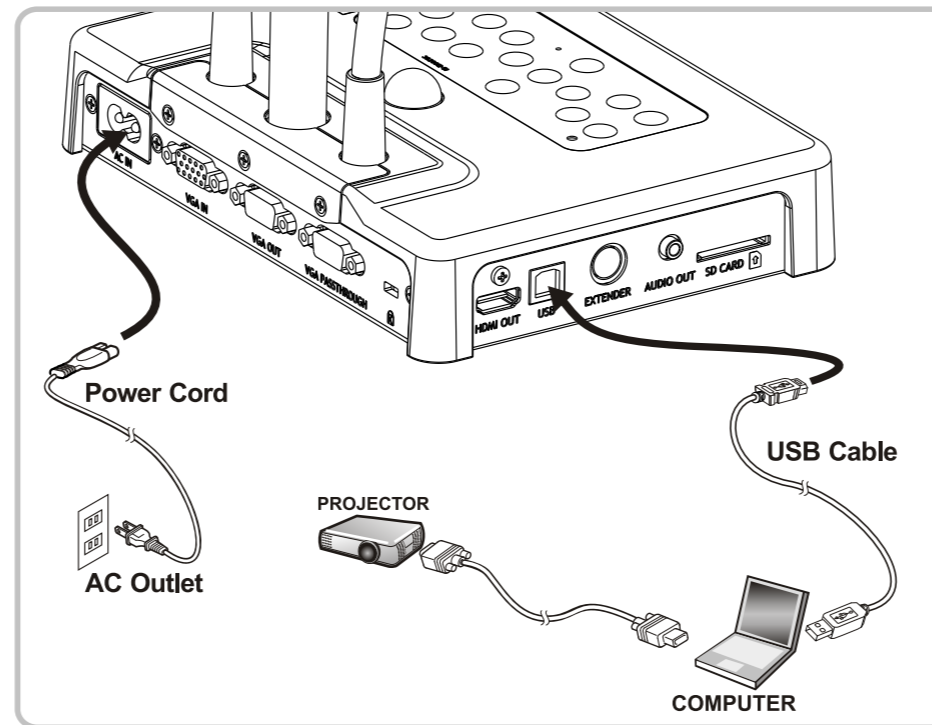

* Driver and software can be downloaded from Lumens website.

▼ Connect a Projector, Computer and Monitor simultaneously

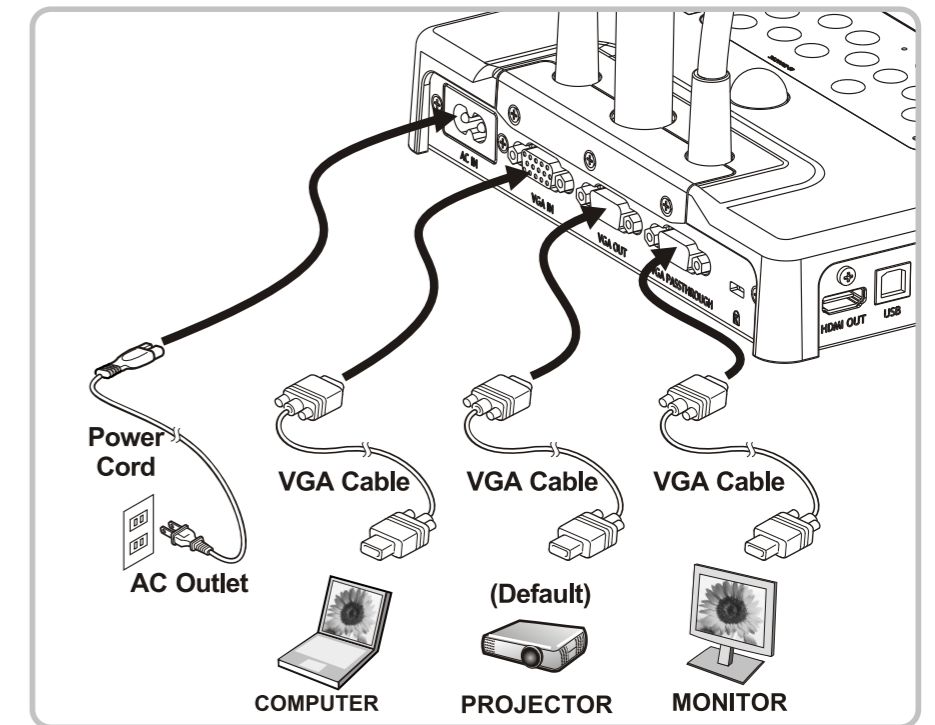

* Press [SOURCE] to change image source from Computer.

▼ Connect to an Interactive Whiteboard (IWB)

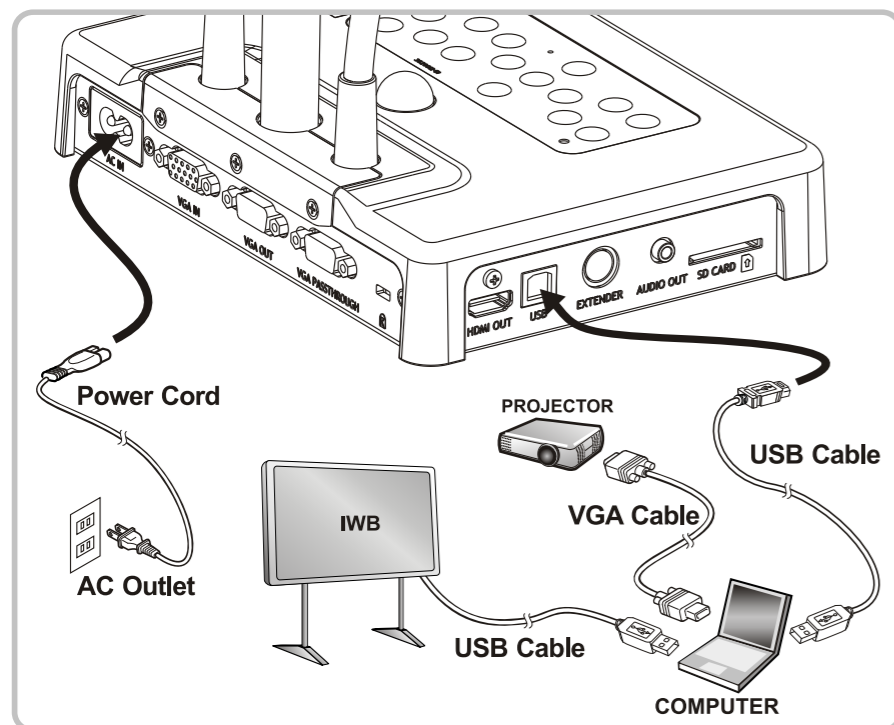

▼ Connect to a TV

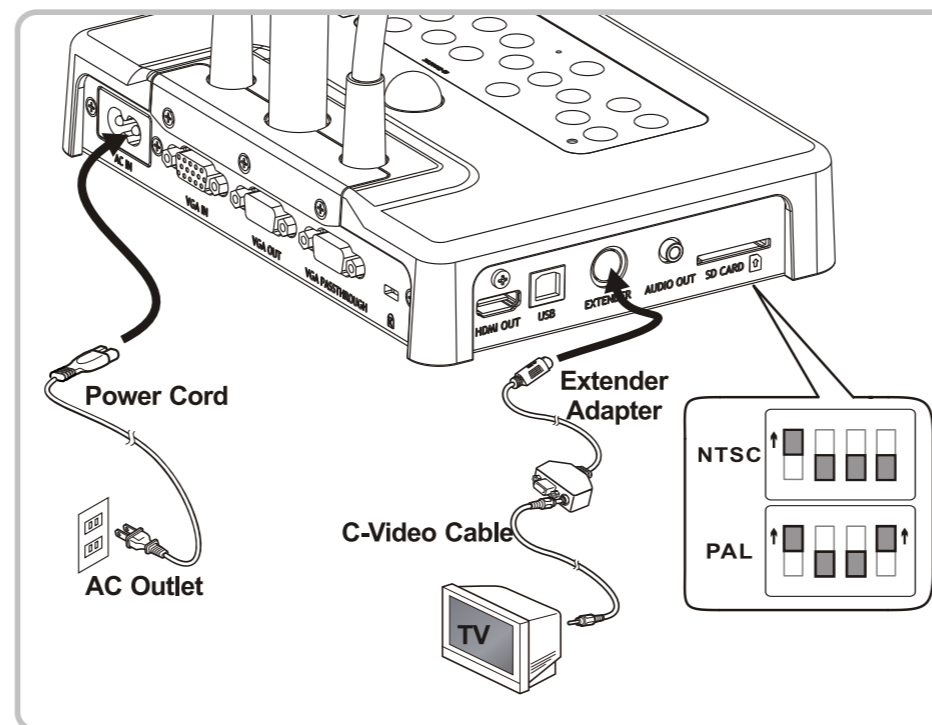

* NTSC: USA, CANADA, MEXICO, PANAMA, CHILE, JAPAN, TAIWAN, KOREA AND PHILIPPINES.
 * PAL: Country / region not listed above.

▼ Connect to an HDTV

