

DC-F20

Document Camera

User Manual - English

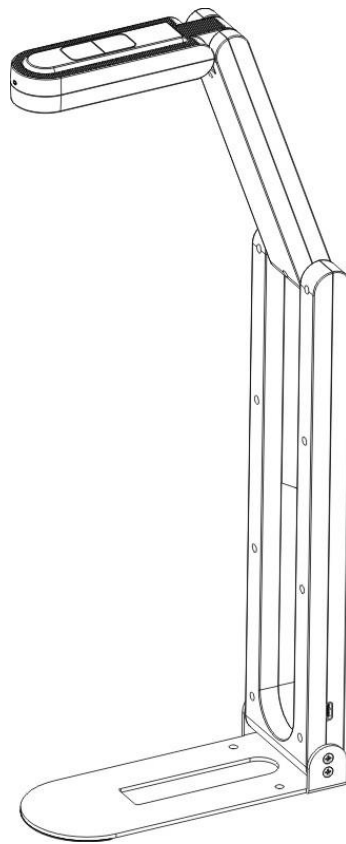

[Important]

To download the latest version of Quick Start Guide, multilingual user manual, software, or driver, etc., please visit Lumens
<https://www.MyLumens.com/support>

Table of Contents

Chapter 1	Package Contents	2
Chapter 2	Product Function Descriptions	3
Chapter 3	Installation and Connections.....	4
	3.1 Document Camera Size.....	4
	3.2 Connecting to a computer.....	5
	3.3 Connecting to an Interactive Whiteboard (IWB).....	5
	3.4 Installing Application Software	5
Chapter 4	Start Using	6
Chapter 5	Descriptions of Major Functions	7
	5.1 Control the Camera.....	7
	5.2 Use Skype for Video Conference.....	7
Chapter 6	Troubleshooting	8
Chapter 7	Safety Instructions	9
	Supplier's Declaration of Conformity 47 CFR § 2.1077 Compliance Information...	11
	Copyright Information.....	12

Chapter 1 Package Contents

DC-F20



USB 2.0 cable, 1.8 M



(Type-C to Type-A)

Chapter 2 Product Function Descriptions

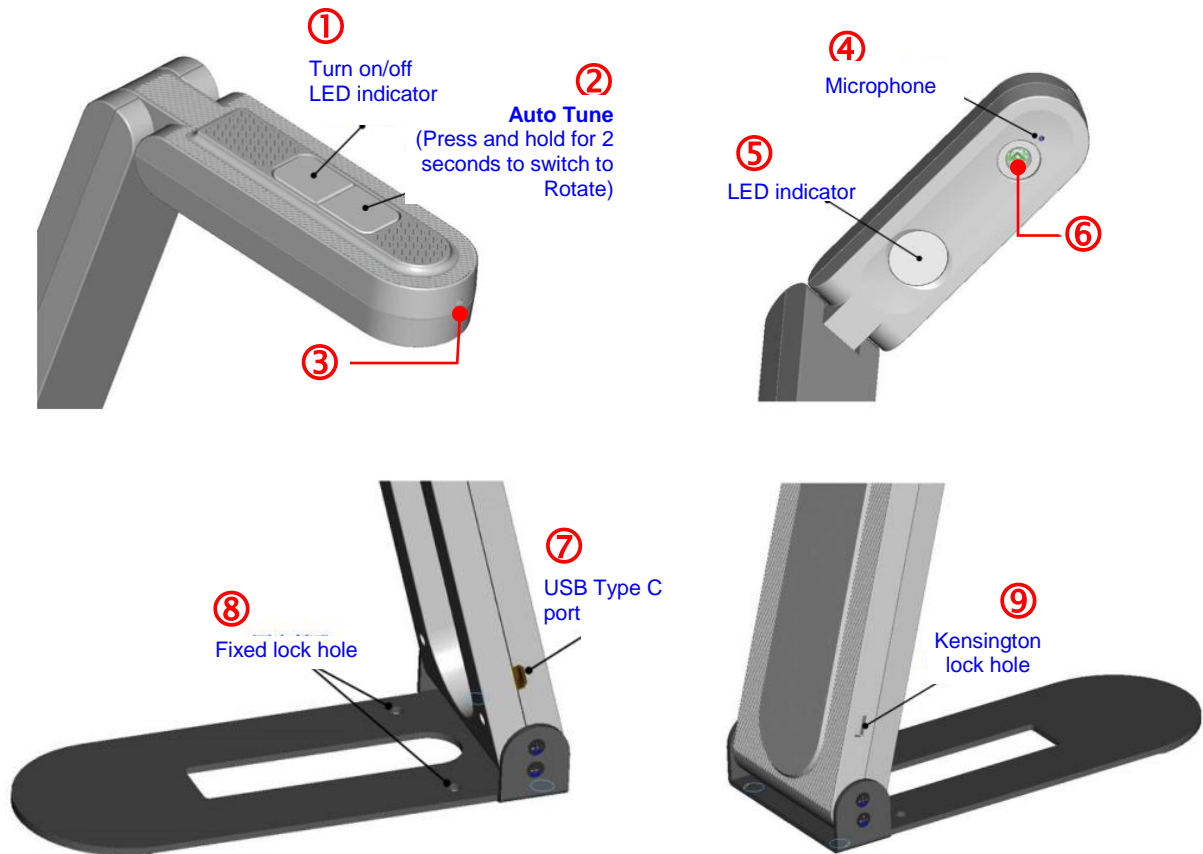

Items	Function	Description
1	LED indicator button	Adjust the brightness of LED indicator (High/Intermediate/Low/Off)
2	Auto Tune/Rotate button	Short press: Automatically adjust the image to have the best brightness and focusing performance Press and hold for 2 seconds: Rotate the image (0°/180°)
3	LED Indicator	LED off: Disable the image LED blue indicator: Image Display
4	Microphone	Built-in microphone
5	LED indicator	Trigger the brightness switch by pressing the upper button
6	Camera lens	HD camera lens
7	USB Type C port	The USB port is for connecting to the USB port of the computer and providing USB signal images * Support up to 2592 x 1944/30 fps
8	Fixed lock hole	Tighten the screws and place the device in the platform
9	Kensington lock hole	Safety lock slot

Chapter 3 Installation and Connections

3.1 Document Camera Size

▪ Length x Width x Height:

Storage compartment: 265 x 65 x 24 mm

Display: 150 x 65 x 404.75 mm

▪ Weight: 310 g

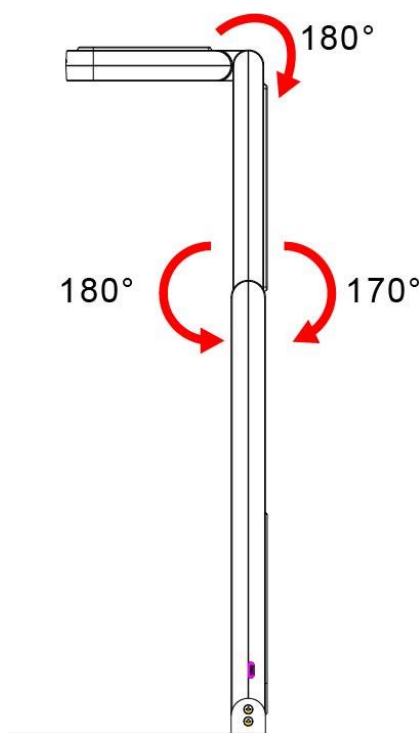
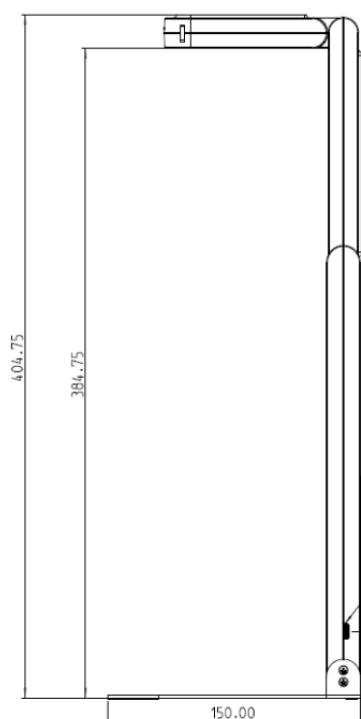
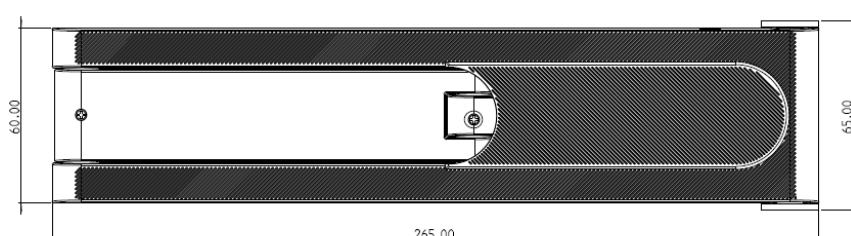

* Please only operate in the extended angles as illustrated. Improper usage may damage the machine.

3.2 Connecting to a computer

* Once the USB is connected to the computer, the power is ON. If the LED is still off, turn on the image via software, and the LED will show blue indicator.

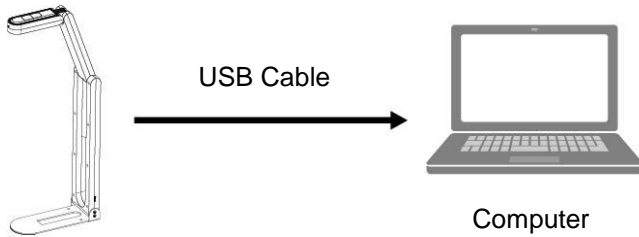

3.3 Connecting to an Interactive Whiteboard (IWB)

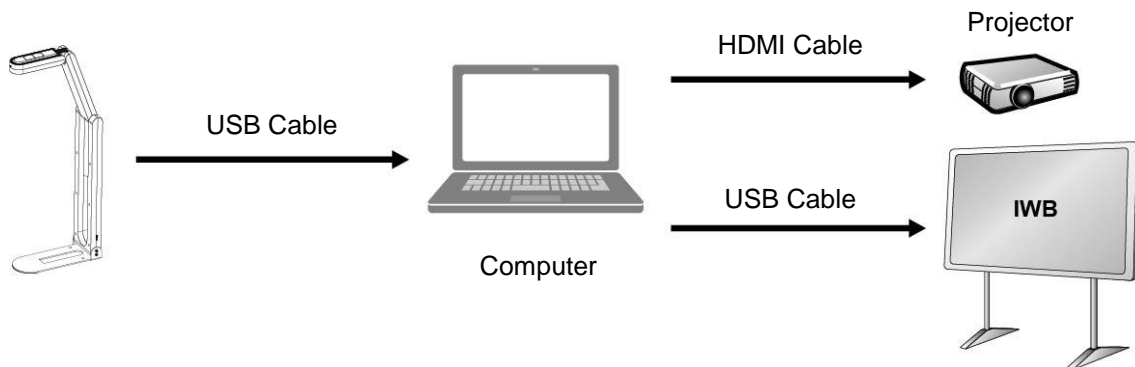

3.4 Installing Application Software

The Lumens Ladibug software installed on the computer enables you to:

- Control DC-F20
- Capture and record images
- Annotate the image, highlight important details and save it
- Support the full screen function.

* Please refer to the software user manual for installation steps and software operation.

- Windows: [Ladibug 4K Software User Manual](#)
- MAC: [Ladibug 3.0 Software User Manual](#)

Chapter 4 Start Using

<Caution> Please make sure that the USB cable is connected and Ladibug™ application software is installed at first. Please refer to [Chapter 3 Installation and Connections](#)

1. After installing Ladibug software, double-click the icon to open the software to view the images and control DC-F20
POWER Frequency setting page will display during the first use, please complete the settings following the instructions on the screen



2. Place an object to be displayed under the camera (For placement of document and display direction of monitor, please refer to the picture below)

* DC-F20 camera coverage is 420 mm x 297 mm (4:3, Size A3 is possible)

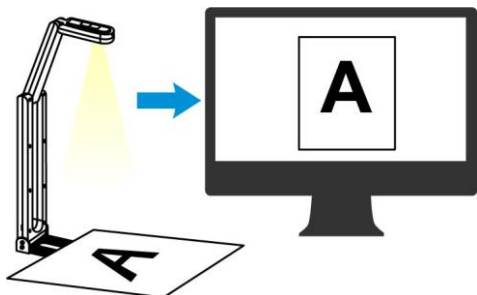

3. Adjust the support arm and lens to the appropriate positions.

4. Press [AUTO TUNE]  button to optimize the image.

5. You are ready to teach/present.

* Please download Ladibug software from Lumens website

* When connected to a computer via a USB cable, DC-F20 can also be used with video software, such as Skype and Zoom.

Chapter 5 Descriptions of Major Functions

5.1 Control the Camera

1. Please download Lumens Ladibug software at Lumens website.
2. Please refer to [Ladibug Software User Manual](#) for software-related functions.

5.2 Use Skype for Video Conference

Please refer to [Chapter 3 Installation and Connections](#) to finish connecting the computer.

Start Skype, select a contact, and press  to start the video conference.

If it doesn't work, please refer to the following steps to setup the camera:

1. Start Skype -> [Setting] -> [Audio & Video]
2. Select [Lumens DC-F20]
3. Select [Lumens DC-F20 Audio]

After the setting is completed, the video conference is ready to begin.

* It can also be used with Zoom, Teams, Google Meet and other video software

Chapter 6 Troubleshooting

This chapter describes problems you may encounter while using DC-F20. If you have questions, please refer to related chapters and follow all the suggested solutions. If the problem still occurred, please contact your distributor or the service center.

No.	Problems	Solutions
1.	When the device is turned on, the LED indicator is off.	Once the USB is connected to the computer, there is no picture output. If the LED indicator is still off, turn on the image via software, and the LED will show blue indicator.
2.	No screen with Ladibug software	<ol style="list-style-type: none">1 Change the USB cable2 Please try the USB port on the back of the computer or other USB port3 Make sure no other application software has DC-F20 images open at the same time. If other software is already using DC-F20 images, Ladibug software cannot output the screen
3.	Unable to focus	Probably the document is too close. Press the pull away the distance between the lens and the document, and then press the upper Auto Tune button to automatically adjust the focal length of image.
4.	DC-F20 cannot operate normally	The machine cannot operate normally probably because the power supply of the USB port at the front end of the computer is insufficient. Try to connect to a USB port at the rear end or a USB hub with a power adapter.
5.	Output screen flicker	The presetting value of Ladibug current frequency is 60 Hz. If current frequency of your local country is 50 Hz, output screen flicker may occur during the use of Ladibug. Please refer to the Camera Settings section of the Software Manual to change the power frequency setting to 50 Hz.

Chapter 7 Safety Instructions

English

Always follow these safety instructions when setting up and using this Product:

1 Operation

- 1.1 Please use the product in the recommended operating environment, away from water or source of heat
- 1.2 Do not place the product on a tilted or unstable trolley, stand or table.
- 1.3 Do not block the slots and openings in the case of the product. They provide ventilation and prevent the product from overheating.
- 1.4 Do not open or remove covers, otherwise it may expose you to dangerous voltages and other hazards. Refer all servicing to licensed service personnel.
- 1.5 Unplug the product from the wall outlet and refer servicing to licensed service personnel when the following situations happen:
 - If the USB port becomes damaged or frayed.
 - If liquid is spilled into the product or the product has been exposed to rain or water.

2 Installation

- 2.1 For security considerations, please make sure the standard hanging rack you bought is in line with UL or CE safety approbations and installed by technician personnel approved by agents.



3 Storage

- 3.1 Do not place the product where the cord can be stepped on as this may result in fraying or damage to the lead or the plug.
- 3.2 Remove the USB cable during thunderstorms or when the product is not used for a long time.
- 3.3 Do not place this product or accessories on top of vibrating equipment or heated objects.

4 Cleaning

- 4.1 Disconnect all the cables prior to cleaning and wipe the surface with a dry cloth. Do not use alcohol or volatile solvents for cleaning.

■ Precautions

	This symbol indicates that this equipment may contain dangerous voltage which could cause electric shock. Do not remove the cover (or back). No user-serviceable parts inside. Refer servicing to licensed service personnel.		This symbol indicates that there are important operating and maintenance instructions in this User Manual with this unit.
---	---	--	---

■ FCC Warning (A)

This equipment has been tested and found to comply with the limits for a Class A digital device, pursuant to part 15 of the FCC Rules. These limits are designed to provide reasonable protection against harmful interference when the equipment is operated in a commercial environment.

Notice :

The changes or modifications not expressly approved by the party responsible for compliance could void the user's authority to operate the equipment..

■ IC Warning

This digital apparatus does not exceed the Class A limits for radio noise emissions from digital apparatus as set out in the interference-causing equipment standard entitled "Digital Apparatus," ICES-003 of Industry Canada.

■ EN55032 CE Warning

Operation of this equipment in a residential environment could cause radio interference.

This unit is intended to be supplied by an UL Listed product suitable for use at maximum ambient temperature 35°C minimum whose output meets LPS (or PS2) and is rating 5Vdc, minimum 500 mA, altitude during operation 2000m minimum.

Français

Respectez toujours les instructions de sécurité lors de la configuration et de l'utilisation de la Document Camera :

1 Opération

- 1.1 Veuillez utiliser le produit dans l'environnement d'exploitation recommandé, à l'écart de l'eau ou d'une source de chaleur.
- 1.2 N'installez pas le produit sur une position inclinée ou sur un chariot, un support ou une table instable.
- 1.3 Ne pas bloquer les orifices et ouvertures du boîtier du produit. La ventilation qu'elles fournissent empêche le produit de surchauffer.
- 1.4 Ne pas ouvrir ou retirer les couvercles sous peine d'exposer les utilisateurs à des tensions électriques dangereuses et à d'autres dangers. Référez-vous pour tout entretien au personnel de service autorisé.
- 1.5 Débranchez le produit de la prise murale et adressez-vous pour l'entretien au personnel de service autorisé dans les situations suivantes :
 - Si le port USB est endommagé ou effiloché.
 - Si du liquide est renversé à l'intérieur du produit ou s'il a été exposé à la pluie ou à de l'eau.

2 Installation

- 2.1 Pour des raisons de sécurité, veuillez vous assurer que le support de suspension standard que vous avez acheté est conforme aux normes de sécurité UL ou CE et qu'il a été installé par un technicien agréé par des agents.

3 Stock.

- 3.1 N'installez pas le produit à un emplacement où le cordon peut être piétiné car cela risque d'effiloche ou d'endommager le cordon ou la prise.
- 3.2 Débranchez le produit pendant les orages ou s'il n'est pas utilisé pendant une longue période.
- 3.3 Ne placez pas le produit ou les accessoires sur le dessus d'un équipement vibrant ou des objets chauffés.

4 Nettoyage

- 4.1 Débranchez tous les câbles avant de nettoyer et essuyez la surface avec un chiffon sec. N'utilisez pas d'alcool ou de solvants volatils pour le nettoyage.

■ Précautions



Ce symbole indique que cet équipement peut contenir une tension dangereuse qui risque de causer une décharge électrique. Ne retirez pas le couvercle (ou la partie arrière). Il n'y a aucune pièce réparable par l'utilisateur à l'intérieur. Veuillez vous référer au personnel de service autorisé.



Ce symbole indique qu'il y a des instructions d'opération et d'entretien importantes dans le manuel d'utilisation accompagnant cet unité.

■ Avertissement de la FCC

Cet équipement a été examiné et avéré être conforme aux limites pour un dispositif numérique de la classe A, conformément à la partie 15 des règlements de la FCC. Ces limites sont conçues pour assurer une protection raisonnable contre une interférence nocive lorsque l'équipement est actionné dans un environnement commercial.

Notice :

Les changements ou modifications non expressément approuvés par la partie responsable de la conformité pourraient annuler le droit de l'utilisateur à utiliser l'équipement.

■ Avertissement de l'IC

Cet appareil numérique respecte les limites de bruits radioélectriques applicables aux appareils numériques de Classe A prescrites dans la norme sur le matériel brouilleur: "Appareils Numériques," NMB-003 édictée par l'Industrie.

■ Avertissement EN55032 CE

L'utilisation de cet équipement dans un environnement résidentiel peut provoquer des interférences radio.

Cet appareil est destiné à être alimenté par un produit répertorié UL adapté à une utilisation à une température ambiante maximale de 35°C minimum dont la sortie est conforme à LPS (ou PS2) et est de 5Vdc, minimum 500mA, altitude pendant le fonctionnement 2000m minimum.

Supplier's Declaration of Conformity

47 CFR § 2.1077 Compliance Information

Manufacturer : Lumens Digital Optics Inc.

Product Name : DC-F20

Model Number : Document Camera

Responsible Party – U.S. Contact Information

Supplier : Lumens Integration, Inc.

4116 Clipper Court, Fremont, CA 94538, United States

e-mail : support@mylumens.com

FCC Compliance Statement

This device complies with Part 15 of the FCC Rules. Operation is subject to the following two conditions : (1) This device may not cause harmful interference, and (2) this device must accept any interference received, including interference that may cause undesired operation.

Copyright Information

Copyrights © Lumens Digital Optics Inc. All rights reserved.

Lumens is a trademark that is currently being registered by Lumens Digital Optics Inc.

Copying, reproducing or transmitting this file is not allowed if a license is not provided by Lumens Digital Optics Inc. unless copying this file is for the purpose of backup after purchasing this product.

In order to keep improving the product, the information in this file is subject to change without prior notice.

To fully explain or describe how this product should be used, this manual may refer to names of other products or companies without any intention of infringement.

Disclaimer of warranties: Lumens Digital Optics Inc. is neither responsible for any possible technological, editorial errors or omissions, nor responsible for any incidental or related damages arising from providing this file, using, or operating this product.