

CL511

Ceiling Camera (Document Camera)

User Manual - English



[Important]

To download the latest version of Quick Start Guide, multilingual user manual, software, or driver, etc., please visit Lumens <https://www.MyLumens.com/support>

Table of Contents

Chapter 1 Package Contents	2
Chapter 2 Function Introduction	3
2.1 Product appearance	3
2.2 Description of LED indicator	4
Chapter 3 Instruction for installation	5
3.1 Size	5
3.2 Relative position of the presenter and document.....	6
3.3 Preparation before installation	7
3.4 Installation steps	7
3.5 System diagram.....	8
Chapter 4 Start Using	9
Chapter 5 Remote Control and Setting Menu.....	10
5.1 Functions of remote control	10
5.2 Setting Menu	11
5.3 Setting menu.....	12
Chapter 6 Descriptions of Major Functions.....	14
Chapter 7 Network Function Settings Description	17
7.1 System Requirements.....	17
7.2 Connecting Camera to Internet.....	17
7.3 Using the Browser to View the Images	18
7.4 Using RTSP Player to View the Images.....	19
7.5 Web Page Function Description	20
Chapter 8 Switch to different output resolutions.....	25
8.1 Switch to different output resolutions	25
Chapter 9 Troubleshooting	26
Chapter 10 Safety Instructions.....	27
Supplier's Declaration of Conformity 47 CFR § 2.1077 Compliance Information	28
Appendix 1	29
Copyright Information	31

Chapter 1 Package Contents

CL511



Quick Start Guide

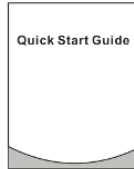

Remote Control



Power Adapter



Power Connector

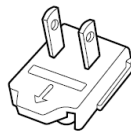

(Appearance may vary depending on country/region)

IR extension cord



USB cable



VGA cable



Hanging parts
U-hanger x 1/mounting
screw x 2

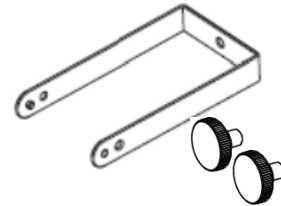

Chapter 2 Function Introduction

2.1 Product appearance

2.1.1 Front View



NO.	Item	Function Descriptions
1.	Camera Lens	30x HD camera lens
2.	IR reception	IR receiver
3.	LED Indicator	Display the status of the camera, please refer to 2.2 Description of LED indicator
4.	Laser Marker LED	Display laser marker
5.	Lock hole	Support 1/4" - 20 UNC Can be mounted on the ceiling with brackets or locked to a tripod
6.	Locating holes	Tripod locating holes
7.	Adjustment screw for laser marker	Adjust the position of the laser marker

2.1.2 Back View

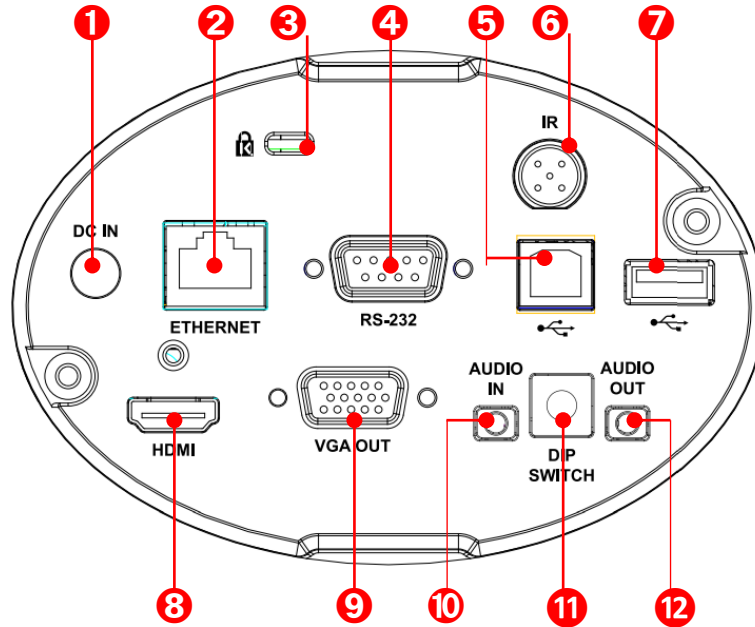

NO.	Item	Function Descriptions
1.	DC 12 V power connector	AC power supply connecting port
2.	Network connection port	Network cable connection port supports routers or hubs of PoE+ (IEEE 802.3at) with power supply
3.	Kensington lock hole	Safety lock slot
4.	RS-232 input	Support RS-232 to control the camera
5.	USB 2.0 port (Type B)	The USB port is for connecting to the USB port of the computer and providing USB signal images
6.	IR Port	Can be used with IR extender
7.	USB 2.0 port (Type A)	Connect a USB to read/store files or connect a mouse to operate the camera
8.	HDMI output	Connect to a display to output HDMI screen
9.	VGA output	Connect to a display to output VGA screen
10.	Audio In	3.5 mm Line In
11.	DIP SWITCH	Adjust the resolution setting. The default is 1080p 60 hz 30 fps
12.	Audio Out	3.5 mm Line Out

2.2 Description of LED indicator

Status	Indicator
Startup in progress (initialization)	Flickering blue light
In use	Blue Light
Powering off	Flickering red light
Power off (Standby)	Red light

Chapter 3 Instruction for installation

3.1 Size

3.1.1 CL511 Size

- Length x Width x Height: 126 x 142 x 86 mm
- Weight : 0.85 Kg (without mental plates)

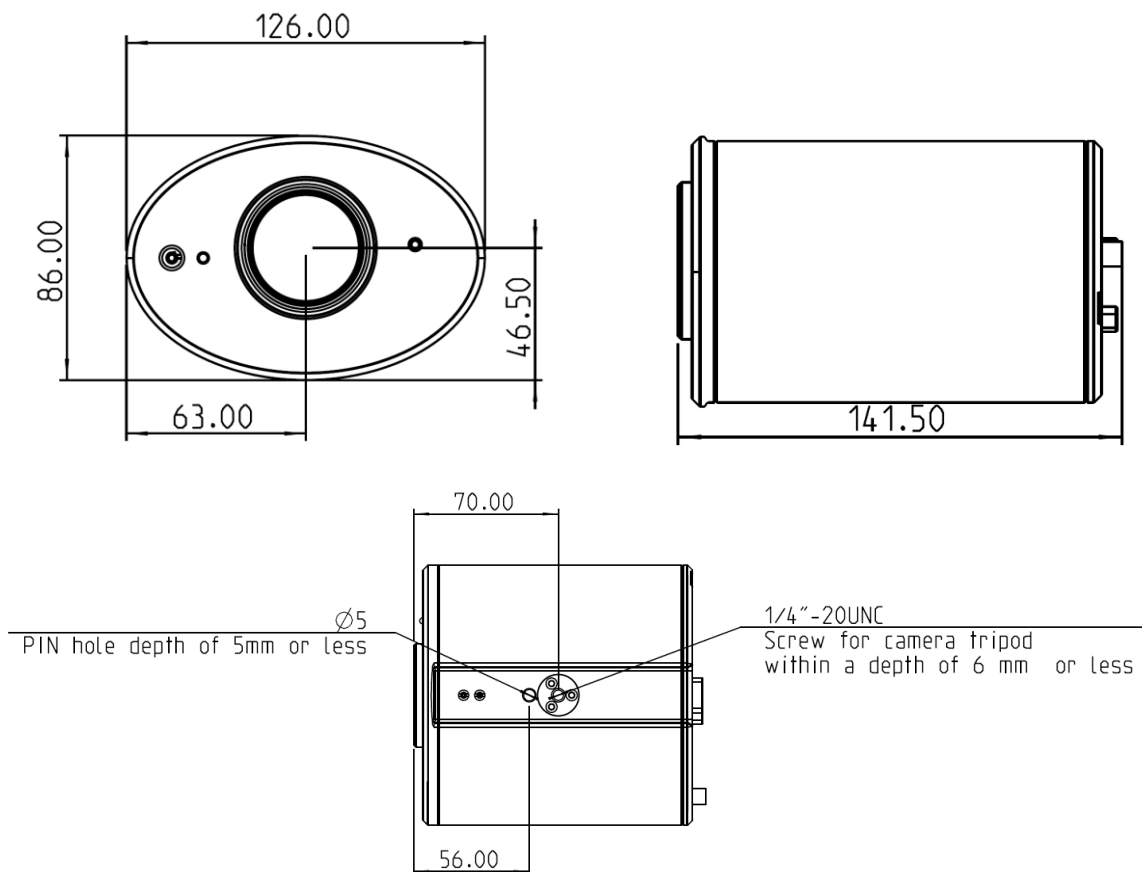

3.1.1.1 Size of CL511 together with U-hanger

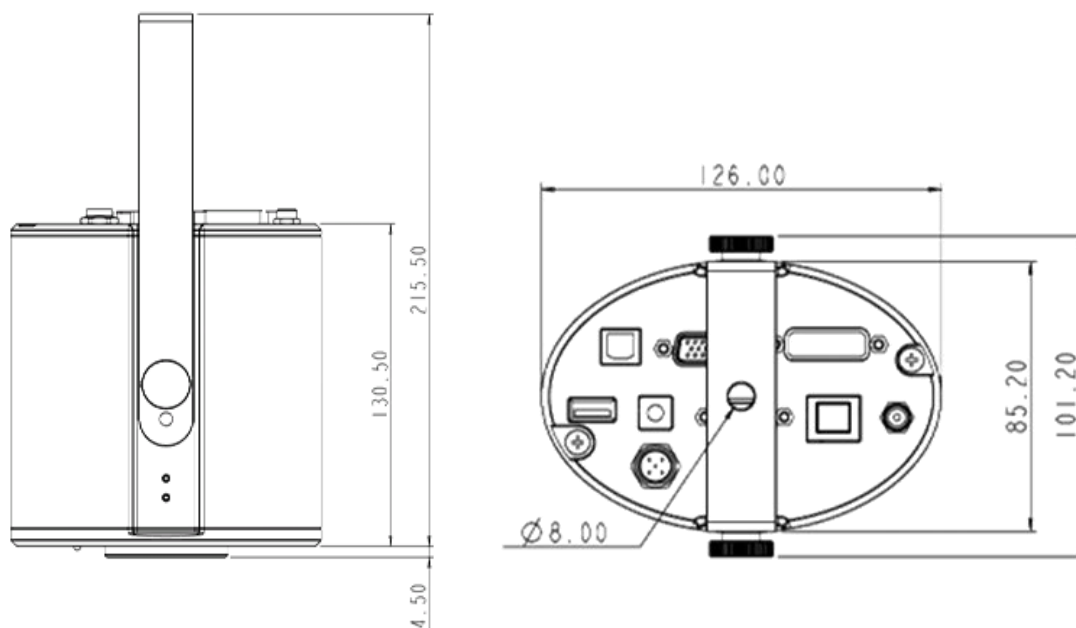

3.1.1.2 Size of U-hanger

<Remark> Please prepare the screw hanger in compliance with the size of the hole used for securing the U-hanger. (Please use UL safety approved hanger for the screw hanger.)

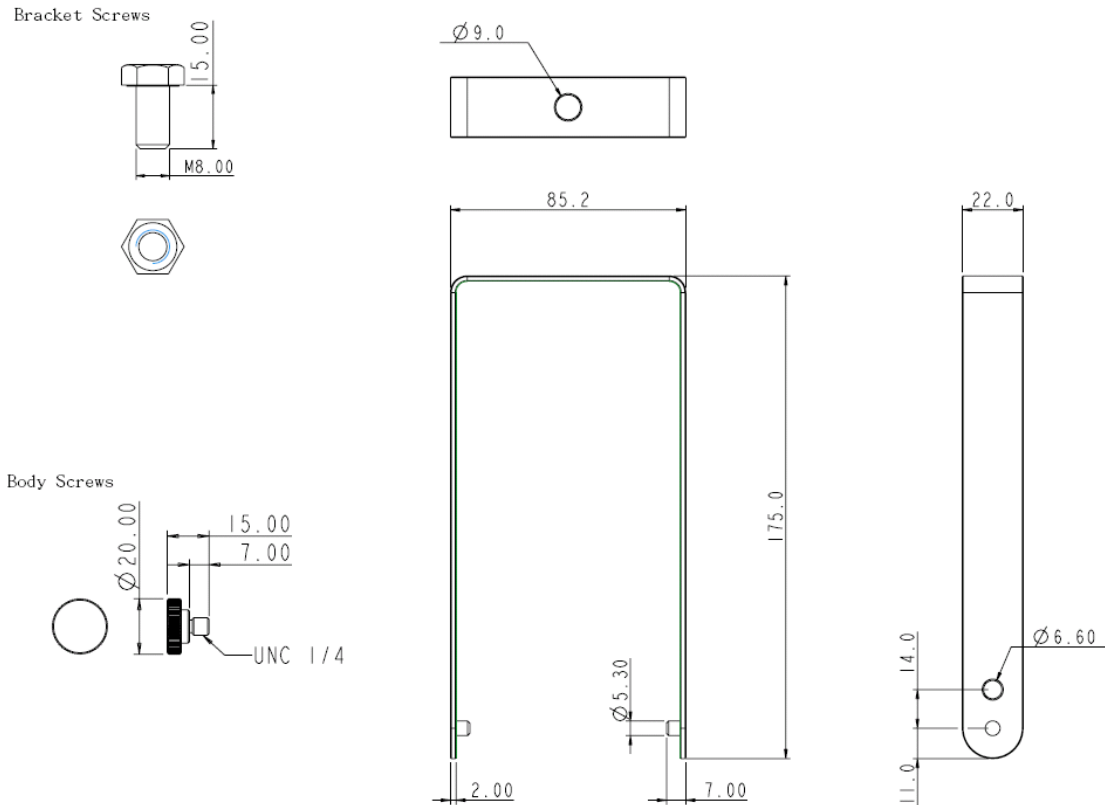

3.2 Relative position of the presenter and document

- To achieve the best effect, upon machine installation, please ensure that the lens is set at a distance of 2 - 5 meters away from the object to be captured.

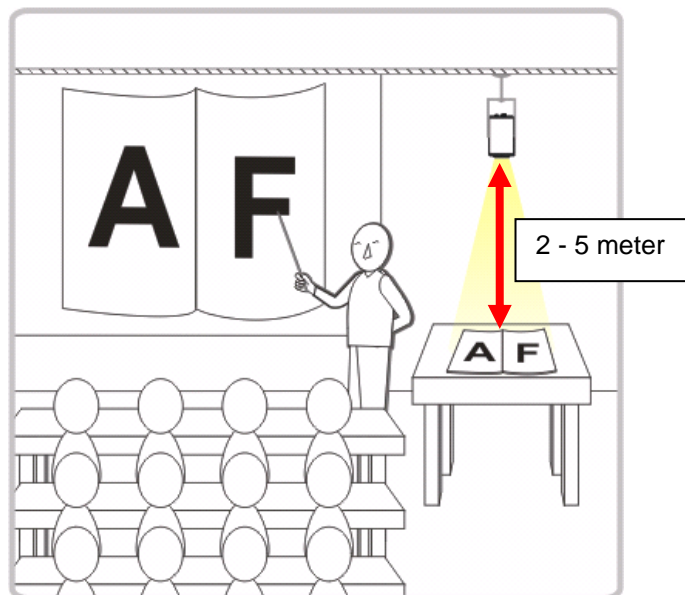

3.3 Preparation before installation

Installation and connection of CL511 Ceiling Camera requires special skills. To install by yourself, please follow necessary steps, ensure steady and tight installation of the device, and pay attention to your safety to avoid any accident.

3.3.1 Preparation before installation

- Ensure the safety of the installation environment. Please do not install the device on unstable ceiling or in a place where the device is in danger of falling to avoid any accident.
- Please check whether accessories in the box are complete or not. Please contact the supplier for any shortage, and make sure to keep the accessories in the box intact.
- Please choose a proper place for installation of CL511 in advance. Please determine an installation place according to the following requirements
 - a. Confirm the position for the object to be captured.
 - b. Calculate the height required for hanging the device according to the position of the object to be captured. If it is not possible to install the device at this height, you need to change the position of the object to be captured.
- Please prepare the following tools for easy installation and shorter installation time.
 - a. Accessories of CL511 in the box
 - b. Hanging parts (ceiling mounted hanger, screw for fixing the hanger 1/4-UNC*4 pcs)
 - c. Drilling machine, screw driver
 - d. Ladder

3.4 Installation steps

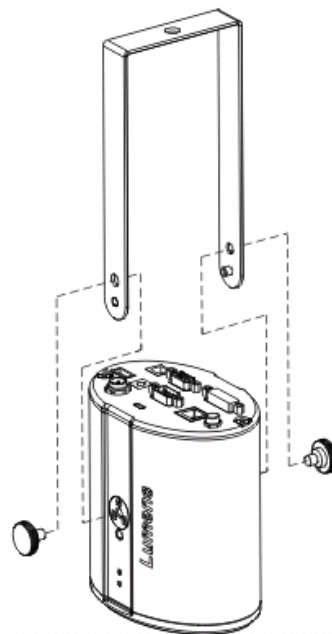

- a. Adjust the output resolution settings based on the specification of the output device
 - Please refer to [Chapter 8 Switch to different output resolutions](#)
 - Please refer to [Appendix 1](#) for applicable frequency depending on different regions.
- b. Assemble the U-hanger and the device using screws supplied
- c. Please follow the instruction for the screw hanger to install it on the ceiling
- d. Screw the device onto the screw hanger and complete the installation
- e. For the first time use, please set the image center position and AF Table data
 - Please refer to [Chapter 4 Getting Started-5.Image Correction Setting](#).

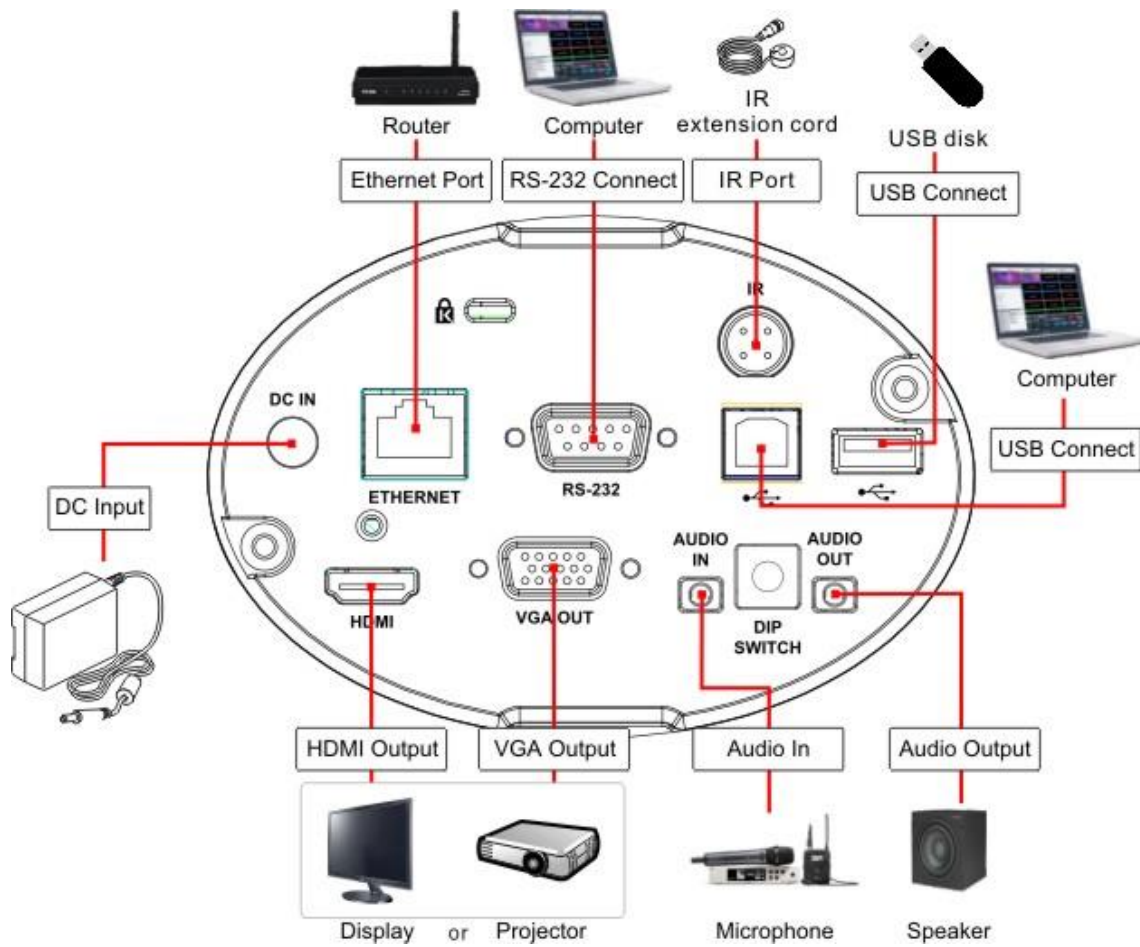

3.5 System diagram









Chapter 4 Start Using



1. Place an object to be displayed under the camera.
2. Press **[POWER]**  on the remote control to power on.
3. Press **[AUTO TUNE]**  button on the remote control to optimize the image.
4. You are ready to teach/present.

<Caution> For the first time use, please follow the steps below for image correction settings.

5. Image Correction Setting

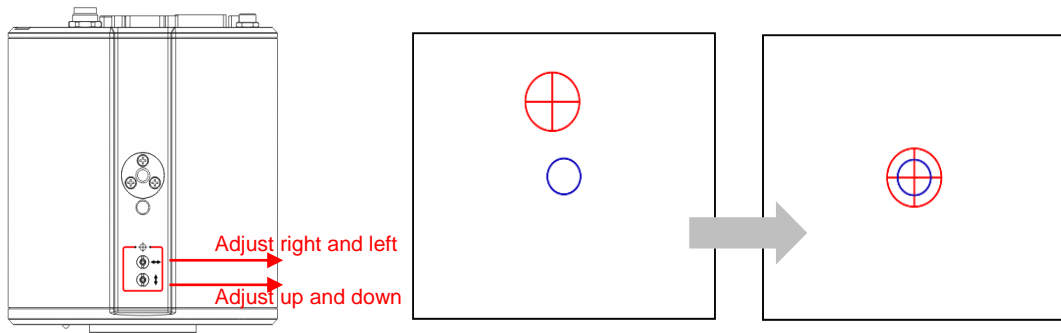
- Set the center location of the image
 - a. Enable the laser mark : Press **[LASER]**  on the remote control
 - b. Open the central positioning marker : Press **[FREEZE]**  > **[DEL]**  > **[LEFT]** 
 - c. Adjust the cross laser mark deviated on the screen to the center point of the blue positioning mark with a hex screwdriver



- Set up AF table
This setting can speed up the AF operation.
 - a. Enter the Service setting menu: Press **[FREEZE]**  > **[DEL]**  > **[ENTER]**  in order on the remote control
 - b. Click **[FOCUS]** > **[ENTER]** for execution

<Remark> The execution time is about 3 - 5 minutes depending on the scene

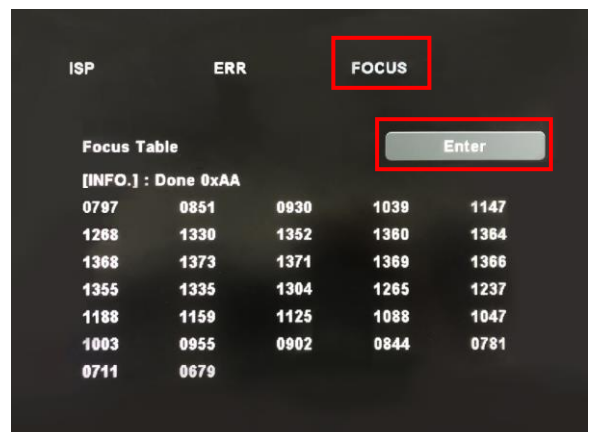

Chapter 5 Remote Control and Setting Menu

5.1 Functions of remote control

- The below functions are listed alphabetically.



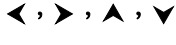















Item	Description
	Power on and off
	Move up, down, left or right to select the needed function
AF	Automatically adjust the focal length of image
AUTO TUNE	Automatically adjust the image to have the best brightness and focusing performance
BRT+/-	Adjust the brightness of the image
CAPTURE	Capture images
DEL	Delete image files
ENTER	Activate/Enter functions
FREEZE	Freeze the current image to remain temporarily on the screen. Press again to defreeze
LASER	Enable/Disable the laser mark
MASK	Activate Mask/Spotlight mode
MENU	Activate the setting menu/exit the menu
PAN	Enable/Disable the partial enlarged mode
PHOTO/TEXT	Select image mode (Photo/Text/Gray)
PIP	Image comparison (to compare live images with stored image files)
PLAYBACK	Read saved files
RECORD	Record motion images. Press [RECORD] to record images and press [RECORD] again to stop recording.
ROTATE	Screen rotation 0°/90°/180°/270°/Flip/Mirror
SLIDE SHOW	Show the photos or videos in slide mode
ZOOM +/-	Increase or decrease the image size

5.2 Setting Menu

5.2.1 Main menu

Press **[MENU]** on the remote control to enter the setting menu.



	Auto Tune Automatically adjust the image to have the best brightness and focusing performance		Playback Preview the photos or videos stored in the USB flash drive (priority) or internal memory card.
	PAN Enable/Disable the partial enlarged mode		Manual Focus Manual Focus
	(Not supported)		Rotate Screen rotation 0°/90°/180°/270°/Flip/Mirror
	PIP Compare live images with stored images		Settings Set up various functions
	Brightness Adjust the brightness of the image		Photo/Text Select Photo/Text/Gray Mode
	Mask Activate the mask mode		Annotation Annotate or mark the image ※ This function can be enabled when a USB mouse is connected.
	Zoom Increase or decrease the image size		Mode Select image mode
	Spotlight Activate the spotlight mode		Exit Exit the setting menu

5.3 Setting menu

5.3.1 Setting Menu

1st Level Major Items	2nd Level Minor Items	Function Descriptions
Capture	Capture Mode	Use left and right arrow keys to select the capture mode (Single Capture/Time Lapse/Record/Off)
	Capture Time	Use the left and right arrow keys to select the capture time. The setting range is 1 ~ 72 hours <Remark> This will be active only when capture mode is set to time lapse
	Capture Interval	Use the left and right arrow keys to select the capture interval. The setting range is 3 seconds ~ 5 minutes <Remark> This will be active only when capture mode is set to time lapse
	Image Quality	Use the left and right arrow keys to select the image quality for the captured images and recorded videos
	Date & Time	Set SNTP server and manually set system time
	Stream	Select Ethernet or USB function <Remark> Ethernet/USB may only choose one, because they cannot be output at the same time
Storage	Slide Show	Show the photos or videos stored in the USB disk (priority) or internal memory in slide mode
	Delay	Use the left and right arrow keys to select the delay time. The range is 0.5 seconds ~ 10 seconds or use manual mode to switch
	Copy To USB Disk	Copy files from internal memory to the USB disk
	Delete All	Delete all images in the USB disk (priority) or internal memory
	Format	Format the USB disk (priority) or internal memory
Control	Auto Exposure	Regardless of outside environment, the machine will adjust the brightness to the optimal condition
	Auto White Balance	Regardless of outside light or color, the machine will adjust the color to the optimal condition
	Audio Out Volume	Use the left and right arrow keys to adjust the Audio Out volume
	Audio In Levels	Use the left and right arrow keys to adjust the Audio In level
	Zoom Limit	Set the Zoom magnification
	Auto Power On	Powers on automatically when connected to power supply
	IP Address	Display the IP address (If it is not connected to a router, the default IP is 192.168.100.100)
Advanced	Language	Support multi-language (default is English)
	Lock Down	Enable/Disable lock down. Select [Enable] to set the password.
	Auto Erase	Enable/Disable Auto Erase. When [Enable] is selected, the stored images will automatically be deleted when the system is turned off.
	Preset Load	Load the stored settings
	Preset Save	Store the value of the current image mode
	Splash Screen Settings	Launch [Splash Screen Settings] window
	Factory Reset	Reset all configurations to factory default settings
	Firmware Version	Show the firmware version

5.3.2 Mask Mode setting menu

Function Items	Function Descriptions
Live	Press [ENTER] to return to live image.
Transparency	Use the left and right arrow keys to adjust the transparency of the mask.
Step	Use the left and right arrow keys to select the step of the mask.
V Size	Use the left and right arrow keys to select the vertical height of the mask.
H Size	Use the left and right arrow keys to select the horizontal length of the mask.
Exit	Press [ENTER] to confirm your selection and exit the mask mode setting menu.

5.3.3 Spotlight Mode setting menu

Function Items	Function Descriptions
Live	Press [ENTER] to return to live image.
Shape	Use the left and right arrow keys to select the shape of the spotlight zone.
Transparency	Use the left and right arrow keys to adjust the transparency of the border in the spotlight mode.
Step	Use the left and right arrow keys to select the step of the spotlight zone.
V Size	Use the left and right arrow keys to adjust the height of the spotlight zone.
H Size	Use the left and right arrow keys to adjust the width of the spotlight zone.
Exit	Press [ENTER] to confirm your selection and exit the spotlight mode setting menu.

5.3.4 Splash Screen Setting







Function Items	Function Descriptions
Power On Image Setting	Select to default/custom power on image
Power On Logo Show Time	Set the duration of displaying the power on logo that can be adjusted between 4 ~ 30 seconds
Power On Image Select	Power On Image Select. <Remark> Only pictures in JPEG format are supported
Exit	Press [ENTER] to confirm your selection and exit splash screen setting window.

5.3.5 Annotation Tools

After connecting the mouse via USB (Type A), right-click to activate the  drawing function of the setting menu

When the mouse stays at the right side of the screen, the annotation menu can be activated.

<Remark> USB screen and mouse drawing can only select one. If you need to use the mouse drawing function, please remove the USB cable

Icon	Description	Icon	Description	Icon	Description
	Custom tool 1		Eraser		Open setting menu of the annotation tool Can set tool/color/line width
	Custom tool 2		Clear all		Exit the annotation tool

Chapter 6 Descriptions of Major Functions

6.1 Automatically adjust the image to have the best brightness and focusing performance

Press [AUTO TUNE] on the remote control to optimize the brightness and focusing performance.

6.2 Make text clearer and photos more colorful

Enter the setting menu, select **[Photo/Text] > [Photo/Text/Gray]**

- **[Photo]** (default): for viewing photos or text with photos, making photos more colorful
- **[Text]**: for viewing text files, making the text clearer
- **[Gray]**: for viewing black & white photos which will make the grayscale differentiation distinct

6.3 Rotate Image

Press **[ROTATE]** key to rotate the screen.

<Remark> The following functions are not available when the image is rotated: PAN/PIP/Recording

6.4 Capture Image

Press **[CAPTURE]** to capture and save images.

- You cannot capture images when the capture mode is set to [Disable]. If it is set to **[Continuous]**, you can capture images continuously by pressing **[CAPTURE]**, or press again to exit.
- To change the quality of images, go to the setting menu **[Settings] > [Capture] > [Image Quality]** to do the setting.

6.5 Record

- Connect USB flash drive to start recording images.
- You may not be able to capture or record images when **[Capture Image]** mode is set to [Disable].
 1. Press **[RECORD]** on the remote control to start recording images.
 2. Press **[RECORD]** again to stop recording.

6.6 View captured/recorded images

1. Press **[PLAYBACK]** to show the thumbnails of all stored files.
2. Select the thumbnail you want to play and press **[ENTER]** to play.
3. When playing the video, press **[FREEZE]** to pause/play the video or press **[ENTER]** to stop playing.
4. Press **[▶]** or **[◀]** to select the next or previous audio/video file.
5. Press **[▲]** or **[▼]** to adjust the volume of the video.

<Remark> An external speaker must be connected to AUDIO OUT to play sound when you use VGA OUT.

6.7 Delete captured/recorded images

1. Press **[PLAYBACK]** to show the thumbnails of all stored files.
2. After selecting the file to be deleted, press **[DEL]** to show the **[Delete File]** window.
3. Select [Yes], press **[ENTER]** to delete the selected file.

6.8 Adjust the output volume

<Remark> Volume control is intended to control the external audio output equipment only.

In PLAYBACK mode, Press **[▲]** or **[▼]** to adjust the volume of the video.

6.9 Automatically delete the stored images whenever it is turned off (Auto Erase)

1. To access the setting menu, select **[Settings] > [Advanced] > [Auto Erase] > [On]** ◦
2. Press **[MENU]** to exit.

6.10 Enlarge a part of the image (PAN)

1. Press **[PAN]** on the remote control to enlarge a part of the image.

2. Press [▲], [▼], [◀], or [▶] to move and view the partial enlarged images.
3. Press [MENU] to exit the partial enlarged mode.

6.11 I would like to use the MASK and Spotlight function

6.11.1 Use the mask/spotlight mode

1. Go to the setting menu and enable [MASK] or [Spotlight] mode.
2. Press [▲], [▼], [◀], or [▶] to move the zone position.
3. Press [MASK] again to return to live image.

6.11.2 I would like to set the size of Mask/Spotlight function

When in **Mask/Spotlight mode**, use the **remote control** to access the setting menu and select the modification item.

- **Mask mode:** [Transparency/Step/V Size/H Size]
- **Spotlight mode:** [Shape/Transparency/Step/V Size/H Size]

(For details, please refer to [5.2 Setting Menu.](#))

- Press [MENU] to exit the Setting Menu and return to Mask/Spotlight mode.

6.12 Play the slides (Slide Show)

6.12.1 Setting delay time

1. Go to the setting menu, select [Settings] > [Storage] > [Delay], and select the delay time

6.12.2 Playing/Pausing/Stopping the slide show

<Remark> Upper limit: The maximum size of single photo is 7 MB.

1. Go to the setting menu and select [Settings] > [Storage] > [Delay] > [ENTER] to execute.
2. Press [ENTER] again to pause/play.

6.13 Use a USB flash drive

Insert the USB flash drive and a **[Copy To USB flash drive]** dialog box will appear, and you are asked whether to copy files from CL511 to the USB flash drive. Press [▶] or [◀] to select.



6.14 Image comparison (to compare live images with stored image files (PIP))

This function will compare and contrast a live image with a stored image.

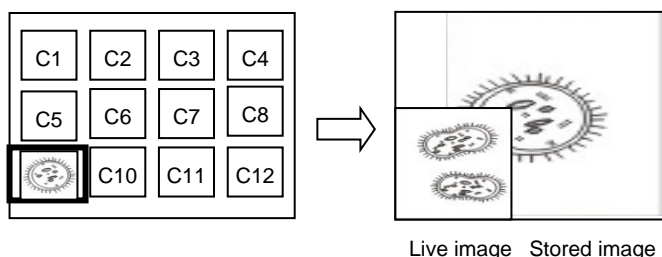

1. Open the thumbnail screen: Go to the setting menu, select [PIP], and choose the image file you want to compare
2. Press [▲], [▼], [◀], or [▶] to move the live image.
3. Repeat Step 1 to change other image files.

6.15 Change the power on image

1. Go to the setting menu, select [Settings] -> [Advanced] -> [Splash Screen Settings].
2. Select [Default/Custom].

- 1.1 If you select [Custom], you can set the [Power On Logo Show Time] and [Select Splash Screen].

<Remark> The power on image file must be less than 5 MB and in JPEG format.

<Remark> To save the file, please follow the instruction below:

- File path: \DCIM\100MEDIA, for example: J:\DCIM\100MEDIA
- File name: four English letters+ four numbers, for example: LUMN0001.JPG

3. Press [▼] to [Exit] and press [ENTER] to exit.

6.16 I would like to save preset number.

1. Adjust the lens to the desired angle
2. Go to the setting menu and select [Settings] > [Advanced] > [Preset Save].
3. Select to save a preset number [1 ~ 8]
4. Press [ENTER] to save the value.

6.17 I want to use the preset number

1. Go to the setting menu and select [Settings] > [Advanced] > [Preset Load]
2. Select to load a preset number [1 ~ 8]
3. Press [ENTER] to read the value.

Chapter 7 Network Function Settings Description

7.1 System Requirements

OS	Version	Browser
Windows	7	IE
		FireFox
		Chrome
	10	Edge
		FireFox
		Chrome
Mac	10.13 above	Safari

7.2 Connecting Camera to Internet

■ Connecting to Internet

Two common connection methods are shown below

1. Connecting via switch or router

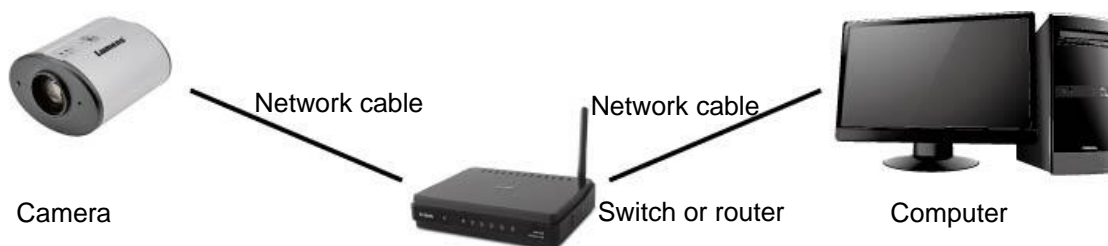

2. To connect directly through network cable, the IP address of the computer should be changed so that it is on the same network segment as the camera

E.g.: The factory default IP address of VC-TR1 is 192.168.100.100. The computer IP address must be set to the same network segment, such as 192.168.100.101, so that the computer can be connected correctly with the camera.

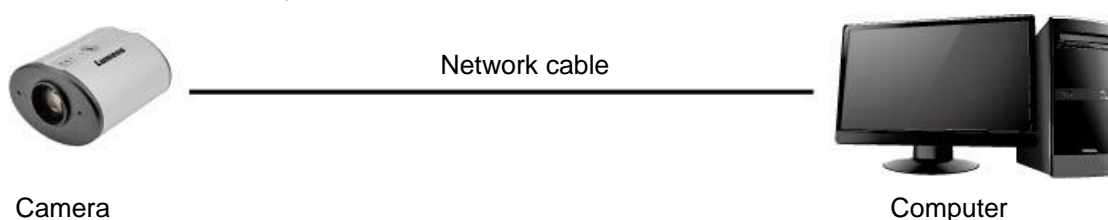

■ Change network settings

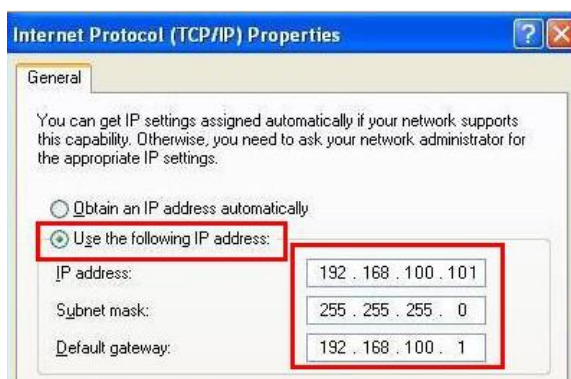

7.3 Using the Browser to View the Images

Use a Cat5e cable to connect to the router to view CL511 video and control it through the web browser

1. Confirm the IP address of the camera

DHCP is on by default. You can use the remote control to open OSD Menu > Check the IP address on the Network.

(If you connect directly with your computer, the default IP of CL511 is 192.168.100.100. Please set your computer to the same network segment.)

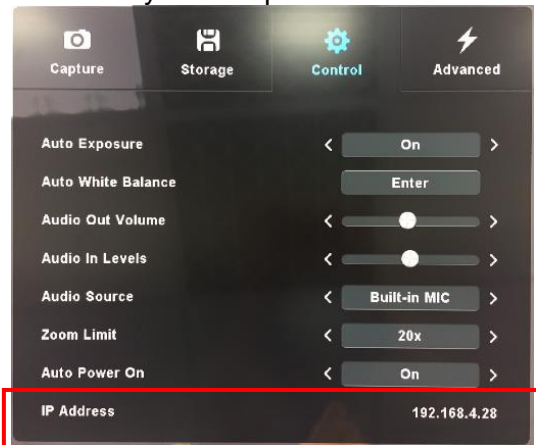

2. Open the browser, and enter the IP address in the address bar

192.168.4.28



3. Enter the account and password to view the images and control CL511 through the web page.

- Account: admin
- Password: 9999

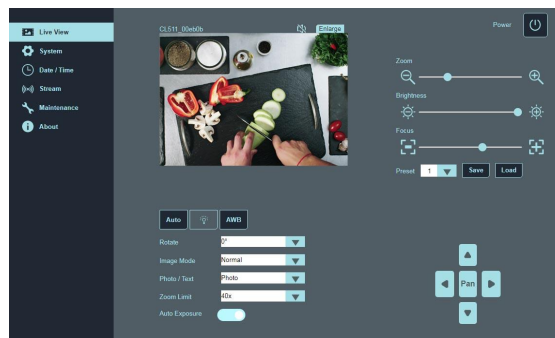

7.4 Using RTSP Player to View the Images

RTSP connections can be made using free software, e.g.: VLC, QuickTime, PotPlayer, etc.

- RTSP connection address formats are as follows: <rtsp://camera IP:8557/h264>
- Example:

Open the VLC software, select [Media] > [Open Network Streaming], and enter the URL:

<rtsp://192.168.4.28:8557/h264>

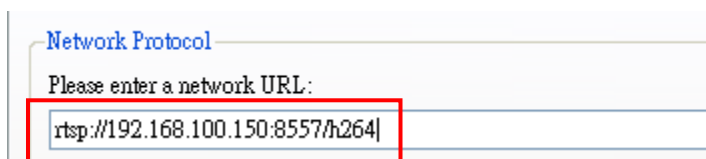
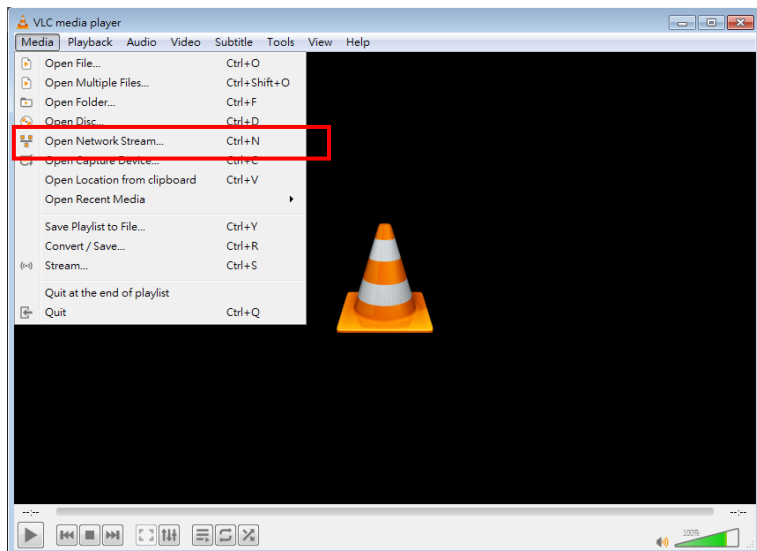

7.5 Web Page Function Description

7.5.1 Login Screen

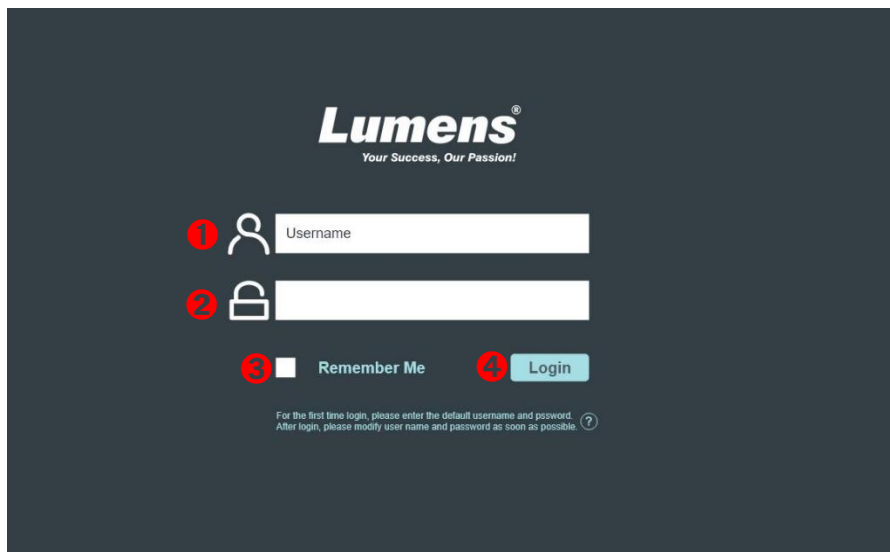

No	Item	Function Descriptions
1	User Login Account	Enter user login account (default: admin)
2	User Password	Enter user password (default: 9999) <Remark> For a first-time login, please refer to 7.5.4 System Settings to change the default password
3	Remember user account and password	Save user login account and password to the browser. When you log in next time, there is no need to re-enter them
4	Login	Log into the administrator screen on the website

7.5.2 Live View-1

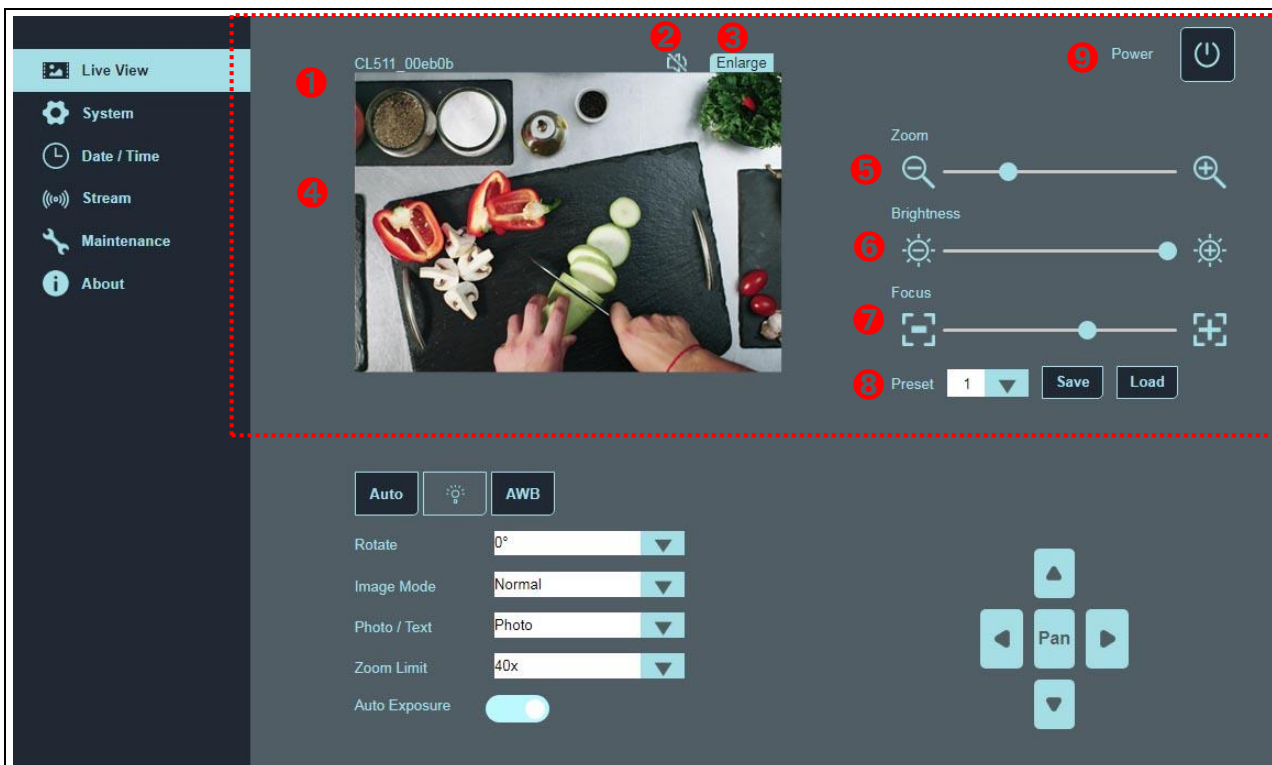

No	Item	Function Descriptions
1	Device Name	Display the device name
2	Audio output	Turn on/off web audio output

3	Enlarge	Switch the preview window to full screen
4	Preview window	Display the screen currently captured by CL511
5	Zoom	Zoom in/out images
6	Brightness	Brightness
7	Focus	Tune the focus
8	Preset	Select preset position (Support 8 groups of preset positions) <ul style="list-style-type: none"> ▪ Save: Save the value according to the current image mode ▪ Load: Load the saved value
9	Power	Enable/Disable CL511

7.5.3 Live View-2

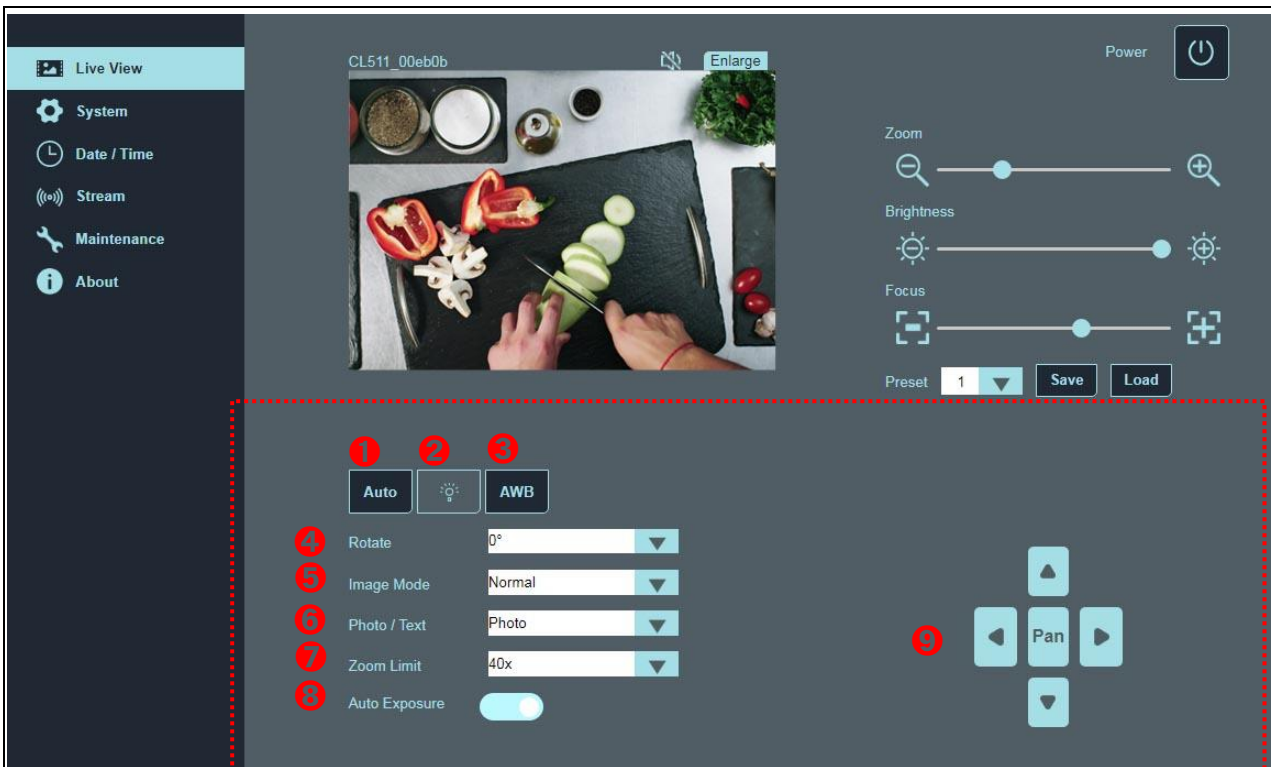

No	Item	Function Descriptions
1	Auto Tune	Automatic Image Optimization; automatically adjust the image to have the best brightness and focal length
2	Lamp	CL511 does not support this feature
3	AWB	Execute Auto White Balance once
4	Rotate	Rotate the image: 0° / 90° / 180° / 270°/Flip/ Mirror
5	Image Mode	Select Normal/Film/Slide Mode
6	Photo / Text	Select Photo/Text/Gray Mode
7	Zoom Limit	Set the Zoom magnification
8	Auto Exposure	Enable/disable auto exposure
9	Pan	Turn on/off partial digital enlarge Arrow keys can move the screen

7.5.4 System Settings

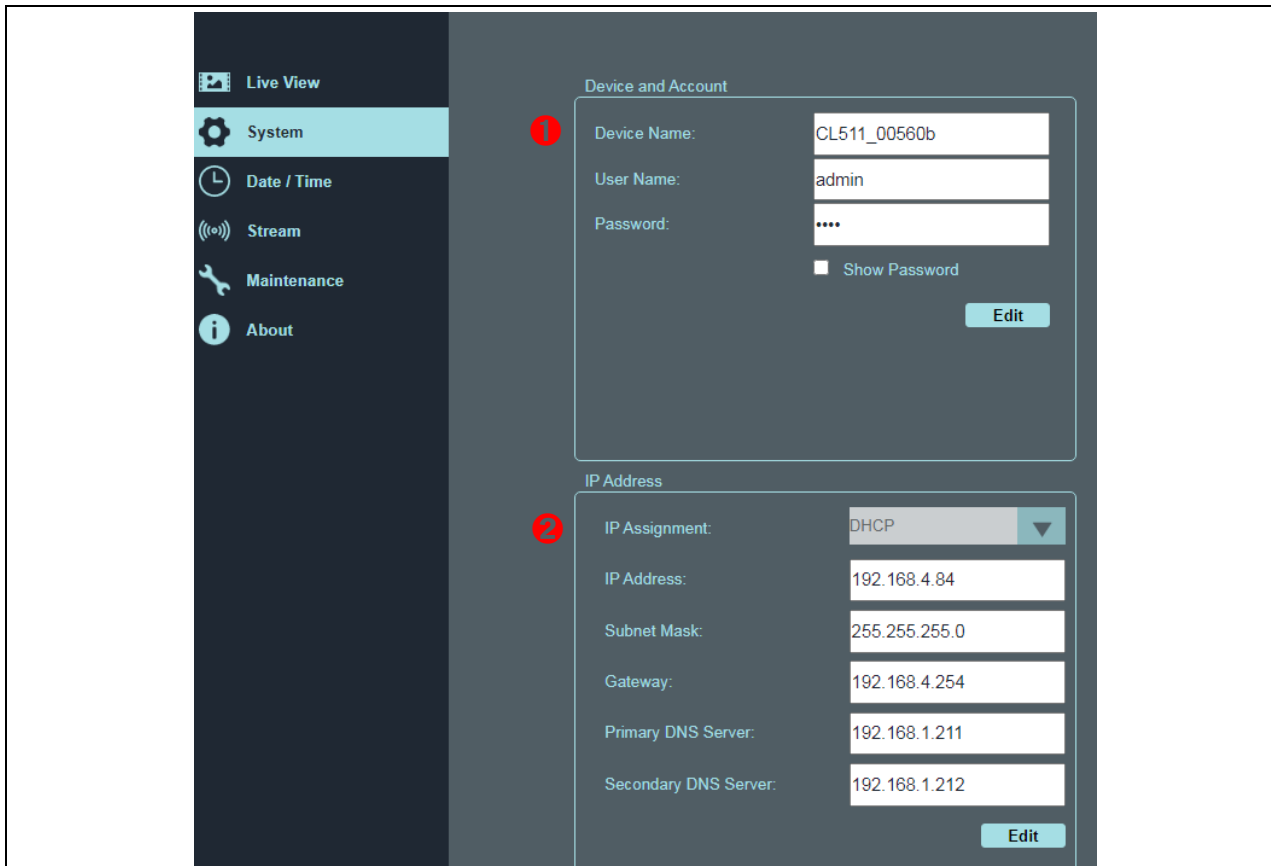

No	Item	Function Descriptions
1	Device and Account	<p>Display the current device name of CL511 and web login settings. Click [Edit] to change the device name, the user account, and the password.</p> <p><Remark> The name/account/password is limited to 1 - 16 characters.</p> <p><Remark> Please use a camera name by mixing uppercase and lowercase letters or numbers. Do not use “/” and “space” or special symbols</p>
2	IP Address	<p>Ethernet Setting.</p> <p>When it is set to Static IP, the setting can be modified.</p>

7.5.5 Date/Time Settings

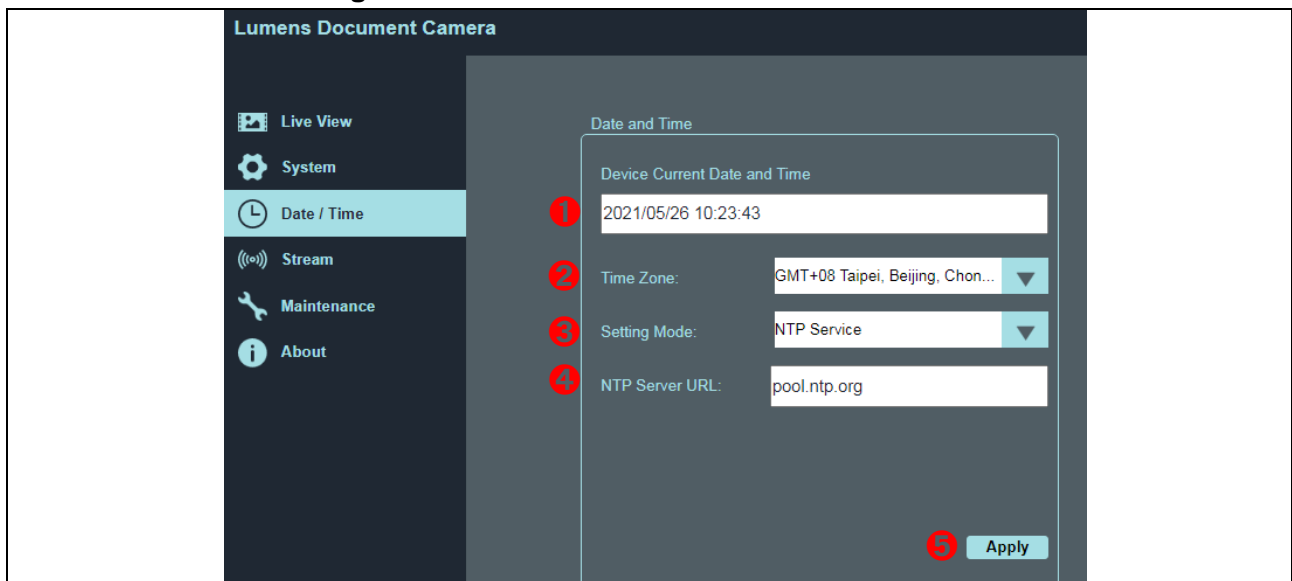

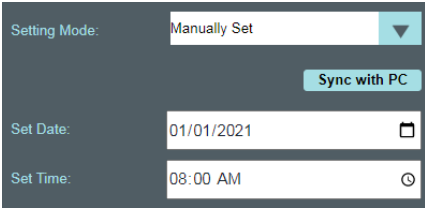
No	Item	Function Descriptions
1	Device Current Date and Time	Display the current system time
2	Time Zone	Set the Time Zone.
3	Setting Mode	<p>Select NTP Service/Manually Set</p> <p>Turn on Manually Set and choose to synchronize with the computer or set the date/time manually.</p> 
4	NTP Server URL	<p>Select NTP service to display this item</p> <p>Connect to a NTP server to correct time</p>
5	Apply	Apply your settings

7.5.6 Streaming Setting

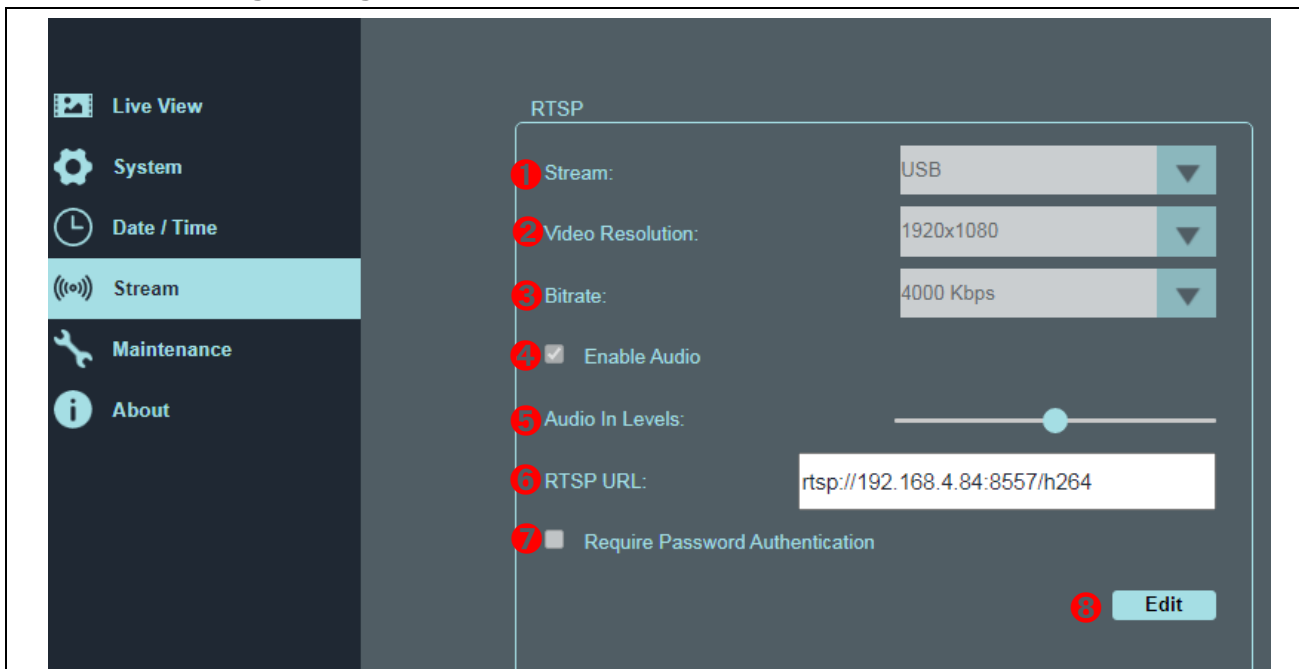

No	Item	Function Descriptions
1	Stream	<p>Switch Ethernet or USB function</p> <p><Remark> Ethernet/USB may only choose one, because they cannot be output at the same time</p>
2	Video Resolution	Show or set the RTSP output resolution
3	Bitrate	Display or set the bit rate of RTSP
4	Enable Audio	Turn on/off RTSP audio
5	Audio In Levels	Adjust Audio In Volume
6	RTSP URL	Display current RTSP URL
7	Require Password Authentication	Enable/disable password authentication
8	Edit	Enter Edit mode

7.5.7 Maintenance

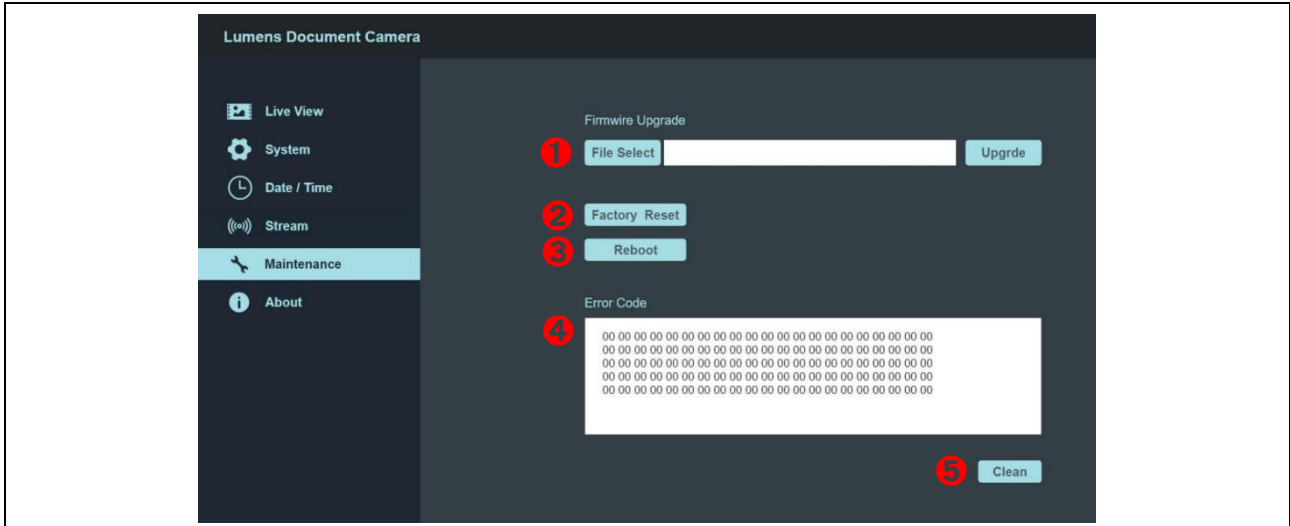

No	Item	Function Descriptions
1	Firmware Upgrade	Select the firmware file, and click [Upgrade] to update the firmware. <Remark> Update takes about 2 - 3 minutes. <Caution> Please do not operate or turn off the power of the device during the update to avoid firmware update failure.
2	Factory Reset	Reset all configurations to factory default settings.
3	Reboot	Restart
4	Error Code	Display system Error code <Remark> When an error code appears, the user may try to clear and confirm if the error will repeat itself
5	Clean	Clear Error code

7.5.8 About

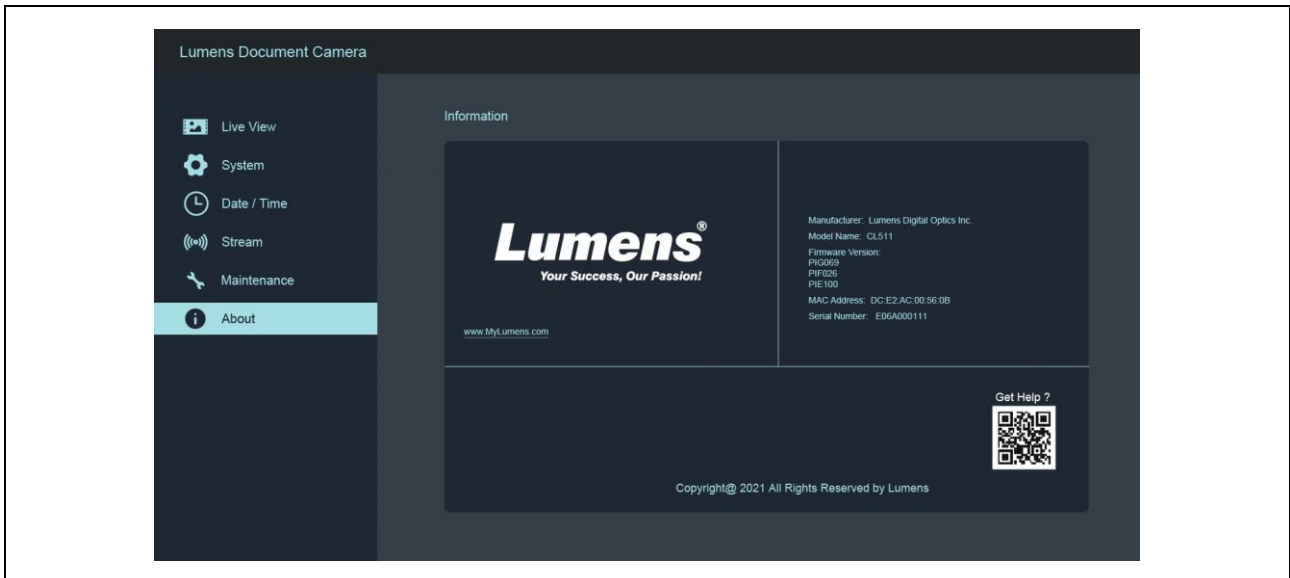

Function Descriptions
Display the firmware version, serial number, and other related information of the camera For technical support, please scan the QRcode at the bottom right.

Chapter 8 Switch to different output resolutions

8.1 Switch to different output resolutions

Unplug and reconnect the power after switching and wait for CL511 to restart before it takes effect.



DIP	Resolution	HDMI	Fps	4KIP ^{Note 1}	High-speed mode ^{Note 2}	Note
0	1080P	60 Hz	30	v		
1		50 Hz	25	v		
2		60 Hz	60		v	
3		50 Hz	50		v	
4	4K	30 Hz	30			VGA does not support 4K.
5		25 Hz	25			
6	1080P	60 Hz	60		v	
7		50 Hz	50		v	
8	720P	60 Hz	30	v		
9		50 Hz	25	v		
A		60 Hz	60		v	
B		50 Hz	50		v	
C	768P	60 Hz	30			
D		60 Hz	25			
E		60 Hz	60		v	
F		60 Hz	50		v	

- **Note 1:** 4K IP mode: IP streaming can support 4K resolution
- **Note 2:** High-speed mode: applicable to support rapidly changing scene

Chapter 9 Troubleshooting

This chapter describes problems you may encounter while using CL511. If you have questions, please refer to related chapters and follow all the suggested solutions. If the problem still occurred, please contact your distributor or the service center.

No.	Problems	Solutions
1.	Boot without power signal	<ol style="list-style-type: none"> 1. Make sure you have plugged in the power cord. 2. When using a PoE connection, ensure that the power supply supports POE+ (IEEE802.3at) hubs
2.	There is no image output from DC172	<ol style="list-style-type: none"> 1. Check the power 2. Check the settings for the source of the projector. Please refer to the user manual of the projector. 3. Check if DIP switch is properly set. Please refer to Chapter 8 Switch to different output resolutions in this manual for related settings.
3.	Unable to focus	<ol style="list-style-type: none"> 1. Probably the document is too close. Press [ZOOM -] on the Remote Control. Or pull away the distance between document and lens, then press [AUTO TUNE]. 2. Please confirm if there is any fingerprint or stain on the lens. Try to use [AUTO TUNE] to focus after cleaning the lens
4.	The images outputted from CL511 are too bright, dark or vague.	Press [AUTO TUNE] to automatically adjust to the optimal brightness and focal length.
5.	The image is incomplete	Check the Auto Image setting of your projector. Please refer to the user manual of the projector or check for the DIP switch setting.
6.	Forget the password for turning on	Please contact your distributor or the service center.
7.	CL511 fails to store images or react.	<ol style="list-style-type: none"> 1. Check to see if the stored data have reached the maximum size of the USB device (priority) or internal memory. 2. Please make sure if the Capture function is set to Continuous mode or the time for capture is set to be long.
8.	Unable to record images	<ol style="list-style-type: none"> 1. Check to see if the stored data have reached the maximum size of the USB disk (priority) or internal memory. 2. Please confirm the rotation angle. You may not able to record when the image is rotated by 90°/270°.
9.	The operating steps in the manual are not applicable to the machine	<p>The operating steps in the manual may be not applicable to the machine due to improvement in functions. Check to see if the Firmware version of your machine is up-to-date.</p> <ul style="list-style-type: none"> ▪ For the latest firmware, please go to Lumens website > Service Support > Download Area. https://www.mylumens.com/support
10.	Unable to login to the network control page	<p>Please confirm whether the [DHCP] is correct.</p> <p>Go to the setting menu > [Advanced] > [Ethernet] > [Dynamic Host Configuration Protocol]</p>
11.	The output image is not clear with water ripples	Please refer to Appendix I of the manual to confirm the voltage frequency, and refer to Chapter 8 Switch to different output resolutions to do the setting.

Chapter 10 Safety Instructions

Always follow these safety instructions when setting up and using the CU-CAT Video Board:

1 Operation

- 1.1 Please use the product in the recommended operating environment, away from water or source of heat
- 1.2 Do not place the product on a tilted or unstable trolley, stand or table.
- 1.3 Please clean the dust on the power plug prior to usage. Do not insert the product's power plug into a multiplug to prevent sparks or a fire.
- 1.4 Do not block the slots and openings in the case of the product. They provide ventilation and prevent the product from overheating.
- 1.5 Do not open or remove covers, otherwise it may expose you to dangerous voltages and other hazards. Refer all servicing to licensed service personnel.
- 1.6 Unplug the product from the wall outlet and refer servicing to licensed service personnel when the following situations happen:
 - If the power cords are damaged or frayed.
 - If liquid is spilled into the product or the product has been exposed to rain or water.

2 Installation

- 2.1 For security considerations, please make sure the standard hanging rack you bought is in line with UL or CE safety approvals and installed by technician personnel approved by agents.

3 Storage

- 3.1 Do not place the product where the cord can be stepped on as this may result in fraying or damage to the lead or the plug.
- 3.2 Unplug this product during thunderstorms or if it is not going to be used for an extended period.
- 3.3 Do not place this product or accessories on top of vibrating equipment or heated objects.



4 Cleaning

- 4.1 Disconnect all the cables prior to cleaning and wipe the surface with a dry cloth. Do not use alcohol or volatile solvents for cleaning.

5 Batteries (for products or accessories with batteries)

- 5.1 When replacing batteries, please only use similar or the same type of batteries
- 5.2 When disposing of batteries or products, please adhere to the relevant instructions in your country or region for disposing of batteries or products

■ Precautions

	This symbol indicates that this equipment may contain dangerous voltage which could cause electric shock. Do not remove the cover (or back). No user-serviceable parts inside. Refer servicing to licensed service personnel.		This symbol indicates that there are important operating and maintenance instructions in this User Manual with this unit.
---	---	--	---

■ FCC Warning

This equipment has been tested and found to comply with the limits for a Class A digital device, pursuant to part 15 of the FCC Rules. These limits are designed to provide reasonable protection against harmful interference when the equipment is operated in a commercial environment.

Notice :

The changes or modifications not expressly approved by the party responsible for compliance could void the user's authority to operate the equipment..

■ IC Warning

This digital apparatus does not exceed the Class B limits for radio noise emissions from digital apparatus as set out in the interference-causing equipment standard entitled "Digital Apparatus," ICES-003 of Industry Canada.

Cet appareil numérique respecte les limites de bruits radioélectriques applicables aux appareils numériques de Classe B prescrites dans la norme sur le matériel brouilleur: "Appareils Numériques," NMB-003 édictée par l'Industrie.

■ FDA Warning

This Device Complies with DHHS Radiation Rules, 21CFR Chapter 1, Subchapter J.

■ EN55032 CE Warning

Operation of this equipment in a residential environment could cause radio interference.

■ EN60825 (Laser) Warning

	Laser Radiation Do Not Stare Into Beam Class 2 Laser Product
---	--

Supplier's Declaration of Conformity 47 CFR § 2.1077 Compliance Information

Manufacturer : Lumens Digital Optics Inc.

Product Name : CL511

Model Number : Document Camera

Responsible Party – U.S. Contact Information

Supplier : Lumens Integration, Inc.

4116 Clipper Court, Fremont, CA 94538, United States

e-mail : support@mylumens.com

FCC Compliance Statement

This device complies with Part 15 of the FCC Rules. Operation is subject to the following two conditions : (1) This device may not cause harmful interference, and (2) this device must accept any interference received, including interference that may cause undesired operation.

Appendix 1

Power frequency for each country in the world

Region or Country		Frequency	Region or Country		Frequency	Region or Country		Frequency
Chinese	English		Chinese	English		Chinese	English	
阿富汗	Afghanistan	50	大陸	China	50	關島	Guam	60
阿爾及利亞	Algeria	50	哥倫比亞	Colombia	60	石榴島	Grenada	50
安哥拉	Angola	50	剛果	Congo	50	瓜地馬拉	Guatemala	60
安地瓜	Antigua	50	哥斯大黎加	Costa Rica	60	幾內亞	Guinea	50
阿根廷	Argentina	50	古巴	Cuba	60	蓋亞納	Gayana	50
澳洲	Australia	50	塞浦路斯	Cyprus	50	海地	Haiti	60
奧地利	Austria	50	捷克	Czechoslovakia	50	夏威夷	Hawaii	60
亞述爾	Azores	50	達荷美	Dahomey	50	宏都拉斯	Honduras	60
巴哈馬	Bahamas	60	丹麥	Den mark	50	香港	Hong Kong	50
巴林	Bahrain	60	多明尼加	Dominican	60	匈牙利	Hungary	50
孟加拉	Bangladesh	50	杜拜	Dubai	50	冰島	Ice land	50
巴貝多	Babados	50	厄瓜多爾	Ecuador	60	印度	India	50
比利時	Belgium	50	埃及	Egypt	50	印尼	Indonesin	50
百慕達	Bermuda	60	薩爾瓦多	El Salvador	60	伊朗	Iran	50
玻利維亞	Bolivia	50	赤道幾內亞	Equatorial Guinea	50	伊拉克	Iraq	50
波札那	Botswana	50	衣索匹亞	Ethiopia	50	愛爾蘭	Ireland	50
巴西	Brazil	50 60	法羅群島	Faeroe Island	50	曼島	Isle of Man	50
保加利亞	Bulgaria	50	斐濟	Fiji	50	以色列	Israel	50
緬甸	Burma	50	芬蘭	Finland	50	義大利	Italy	50
蒲隆地	Burundi	50	法國	France	50	象牙海岸	Ivory Coast	50
高棉	Cambodia	50	蓋亞那	French Guiana	50	牙買加	Jamaica	50
喀麥隆	Cameroon	50	加彭	Gabon	50	日本	Japan	50 60
加拿大	Canada	60	甘比亞	Gambia	50	約旦	Jordan	50
康那利群島	CanaryIsland	50	德國	Germany	50	肯亞	Kenya	50
中非共和國	Central Africa Rep.	50	迦納	Ghana	50	韓國	Korea	60
錫蘭	Ceylon	50	直布羅陀	Gibraltar	50	科威特	Kuwait	50
查德	Chad	50	大不列顛	Great Britain	50	黎巴嫩	Lebanon	50
海峽群島	Channel Island	50	希臘	Greece	50	賴索托	Lesotho	50
智利	Chile	50	格陵蘭	Greenland	50	賴比瑞亞	Liberia	60
利比亞	Libya	50	阿曼	Oman	50	敘利亞	Syria	50
盧森堡	Luxembourg	50	巴基斯坦	Pakistan	50	大溪地	Tahiti	60

Region or Country		Frequency	Region or Country		Frequency	Region or Country		Frequency
Chinese	English		Chinese	English		Chinese	English	
澳門	Macao	50	巴拿馬	Panama	60	中華民國	R.O.C. Taiwan	60
馬得拉群島	Madeiral	50	巴拉圭	Paraguay	50	坦尚尼亞	Tanzania	50
馬約卡島	Majokca Island	50	秘魯	Peru	60	泰國	Thailand	50
馬拉加西	Malagasy	50	菲律賓	Philippines	60	多哥共和國	Togo Rep.of	50
馬拉威	Malawi	50	波蘭	Poland	50	東加	Tonga	50
馬來西亞	Malaysia	50	葡萄牙	Portugal	50	千里達	Trinidad	60
馬利	Mali Rep.	50	波多黎各	Puerto Rico	60	他巴哥	Tobago	60
馬爾他	Malta	50	科托	Qatar	50	突尼西亞	Tunisia	50
馬丁尼克島	Martinique	50	羅德西亞	Rhodesia	50	土耳其	Turkey	50
茅里塔尼亞	Mauritania	50	羅馬尼亞	Romania	50	烏干達	Uganda	50
模里西斯	Mauritius	50	盧安達	Rwanda	50	美國	USA.	60
墨西哥	Mexico	60	沙烏地阿拉伯	Saudi Arabia	50 60	蘇聯	USSR	50
摩那哥	Monaco	50	蘇格蘭	Scotland	50	英國	United Kingdom	50
蒙特色納島	Montserrat	60	塞內加爾	Senegal	50	上伏塔	Upper Volta	50
摩洛哥	Morocco	50	獅子山	Sierra Leone	50	烏拉圭	Uruguay	50
莫桑鼻克	Mozambique	50	新加坡	Singapore	50	委內瑞拉	Venezuela	60
尼泊爾	Nepal	50	索馬利亞	Somalia	50	越南	Viet-Nam	50
荷蘭	Netherlands	50	南非共和國	South Africa Rep.	50	維爾京群島	Virgin Island	60
新蘇格蘭	New Caledonia	50	西班牙	Spain	50	西薩摩亞	Western Samoa	50
紐西蘭	New Zealand	50	斯里蘭卡	Sri Lanka	50	葉門亞丁	Yeman(Aden)	50
尼加拉瓜	Nicaragua	60	蘇丹	Sudan	50	葉門阿拉伯	Yemen(Arab)	50
尼日	Niger	50	蘇利南	Surinam	60	南斯拉夫	Yugoslavia	50
奈及利亞	Nigeria	50	史瓦濟蘭	Swaziland	50	薩伊共和國	Zaire Rep. of	50
挪威	Norway	50	瑞典	Sweden	50	尚比亞	Zambia	50
琉球	Okinawa	60	瑞士	Switzerland	50			

Copyright Information

Copyrights © Lumens Digital Optics Inc. All rights reserved.

Lumens is a trademark that is currently being registered by Lumens Digital Optics Inc.

Copying, reproducing or transmitting this file is not allowed if a license is not provided by Lumens Digital Optics Inc. unless copying this file is for the purpose of backup after purchasing this product.

In order to keep improving the product, the information in this file is subject to change without prior notice.

To fully explain or describe how this product should be used, this manual may refer to names of other products or companies without any intention of infringement.

Disclaimer of warranties: Lumens Digital Optics Inc. is neither responsible for any possible technological, editorial errors or omissions, nor responsible for any incidental or related damages arising from providing this file, using, or operating this product.